



INSTRUCTION MANUAL

VHF/HF ALL MODE TRANSCEIVER **IC-746**

This device complies with Part 15 of the FCC rules. Operation is subject to the following two conditions: (1) This device may not cause harmful interference, and (2) this device must accept any interference received, including interference that may cause undesired operation.

IMPORTANT

READ THIS INSTRUCTION MANUAL CAREFULLY before attempting to operate the transceiver.

SAVE THIS INSTRUCTION MANUAL—This manual contains important safety and operating instructions for the IC-746.

PRECAUTIONS

⚠ WARNING! HIGH VOLTAGE! NEVER attach an antenna or internal antenna connector during transmission. This may result in an electric shock or burn.

⚠ NEVER apply AC to the [DC13.8V] socket on the transceiver rear panel. This could cause a fire or ruin the transceiver.

⚠ NEVER apply more than 16 V DC, such as a 24 V battery, to the [DC13.8V] socket on the transceiver rear panel. This could cause a fire or ruin the transceiver.

⚠ NEVER let metal, wire or other objects touch any internal part or connectors on the rear panel of the transceiver. This may result in an electric shock.

NEVER allow children to play with equipment containing a radio transmitter.

NEVER expose the transceiver to rain, snow or any liquids.

AVOID using or placing the transceiver in areas with temperatures below -10°C ($+14^{\circ}\text{F}$) or above $+60^{\circ}\text{C}$ ($+140^{\circ}\text{F}$). Be aware that temperatures on a vehicle's dashboard can exceed 80°C ($+176^{\circ}\text{F}$), resulting in permanent damage to the transceiver if left there for extended periods.

AVOID placing the transceiver in excessively dusty environments or in direct sunlight.

AVOID placing the transceiver against walls or putting anything on top of the transceiver. This will obstruct heat dissipation.

During mobile operation, **DO NOT** operate the transceiver without running the vehicle's engine. When transceiver power is ON and your vehicle's engine is OFF, the vehicle's battery will soon become exhausted.

Make sure the transceiver power is OFF before starting the vehicle. This will avoid possible damage to the transceiver by ignition voltage spikes.

During maritime mobile operation, keep the transceiver and microphone as far away as possible from the magnetic navigation compass to prevent erroneous indications.

BE CAREFUL! The heatsink will become hot when operating the transceiver continuously for long periods.

BE CAREFUL! If a linear amplifier is connected, set the transceiver's RF output power to less than the linear amplifier's maximum input level, otherwise, the linear amplifier will be damaged.

Use Icom microphones only (supplied or optional). Other manufacturer's microphones have different pin assignments and connection to the IC-746 may damage the transceiver.

EXPLICIT DEFINITIONS

The explicit definitions described below apply to this instruction manual.

WORD	DEFINITION
⚠ WARNING	Personal injury, fire hazard or electric shock may occur.
CAUTION	Equipment damage may occur.
NOTE	If disregarded, inconvenience only. No risk of personal injury, fire or electric shock.



The IC-746's which display the "CE" symbol, comply with the essential requirements of the 89/336/EEC directive for Electromagnetic Compatibility. This compliance is based on conformity with the ETSI specification prETS300 684 (EMC product standard for Commercially Available Amateur Radio Equipment).

BUILT-IN DSP



The IC-746's DSP digitally transposes receive audio components in all modes of operation to produce desired AF frequency characteristics at the IF stage of the transceiver. DSP provides the following functions:

- ⇒ *Noise reduction*—reduces various types of noise and enhances receive signal components only.
- ⇒ *Automatic notch filter*—automatically reduces single beat interference and protects the receive voice signals.
- ⇒ *Selectable APF*—a total of 3 passband widths are selectable (80/160/320 Hz), for super-narrow filter APF functions in CW mode. The APF center frequency is adjustable.

TABLE OF CONTENTS

IMPORTANT	ii	7-3 Transferring a memory to VFO	50
PRECAUTIONS	ii	7-4 Clearing a memory	50
EXPLICIT DEFINITIONS	ii	7-5 Selecting the call channel	51
BUILT-IN DSP	ii	7-6 Programming a memory	51
TABLE OF CONTENTS	iii	7-7 Programming the call channel	52
1 PANEL DESCRIPTION	2-7	7-8 Programming scan edges	52
1-1 Front panel	2	7-9 Assigning memory names	53
1-2 Rear panel	6	7-10 Memo pads	54
1-3 Function display	7	8 SCAN OPERATION	55-58
2 MENU SELECTION	8-9	8-1 Scan types	55
2-1 Menu set 1 flow chart	8	8-2 Programmed scan and fine programmed scan	56
2-2 Menu set 2 flow chart	9	8-3 Memory scan	57
3 BASIC OPERATION	10-17	8-4 Select memory scan	57
3-1 Before operating	10	8-5 Δ F scan and fine Δ F scan	58
3-2 Squelch and receive (RF) sensitivity	12	9 INTERNAL ANTENNA TUNER	59
3-3 Selecting VFO/memory mode	13	9-1 Before operating	59
3-4 Toggling between VFO A/B and transferring contents	13	9-2 Tuner operation	59
3-5 Setting a band and frequency	14	10 SET MODE	60-64
3-6 Selecting an operating mode	17	10-1 Selecting set mode	60
4 USING DIFFERENT OPERATING MODES .	18-36	10-2 Set mode items	60
4-1 Operating SSB	18	11 ADJUSTMENTS	65-66
4-2 Operating CW	20	11-1 Tuning dial brake	65
4-3 Operating RTTY (FSK)	28	11-2 Frequency calibration	65
4-4 Operating AM	30	11-3 Measuring SWR	66
4-5 Operating FM	32	11-4 Adjusting the LCD	66
4-6 Repeater operation	34	12 SETUP AND CONNECTIONS	67-75
4-7 Packet operation	36	12-1 Front panel	67
5 FUNCTIONS FOR RECEIVE	37-42	12-2 Rear panel	68
5-1 Simple band scope	37	12-3 Selecting a location	69
5-2 Preamp and attenuator	38	12-4 Power supply connections	69
5-3 RIT function	38	12-5 Grounding	70
5-4 AGC function	39	12-6 Antenna	70
5-5 1/4 function	39	12-7 Data communications	72
5-6 NB function	39	12-8 RTTY connections	73
5-7 Noise reduction	40	12-9 Remote jack	74
5-8 Auto notch (ANF) function	40	13 OPTIONAL INSTALLATIONS	76-80
5-9 Dial lock function	40	13-1 Opening the transceiver's case	76
5-10 Twin PBT	41	13-2 UT-102 VOICE SYNTHESIZER UNIT	77
5-11 Selecting IF filters	42	13-3 CR-282 HIGH STABILITY CRYSTAL UNIT	77
6 FUNCTIONS FOR TRANSMIT	43-48	13-4 Optional IF filters	78
6-1 VOX function	43	13-5 Linear amplifier connections	79
6-2 Break-in function	44	13-6 External antenna tuner connections	80
6-3 Δ TX function	45	14 MAINTENANCE	81-83
6-4 Monitor function	45	14-1 Fuse replacement	81
6-5 Speech compressor	46	14-2 Resetting the CPU	81
6-6 Split frequency operation	47	14-3 Troubleshooting	82
6-7 Quick split function	48	15 SPECIFICATIONS AND OPTIONS	84-85
7 MEMORY CHANNELS	49-54	15-1 Specifications	84
7-1 General	49	15-2 Options	85
7-2 Memory channel selection	49		

1-1 Front panel

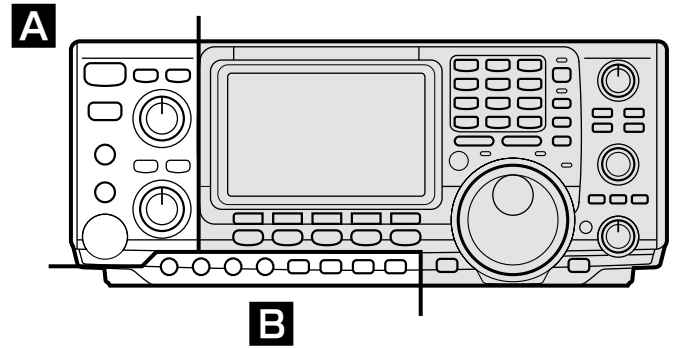
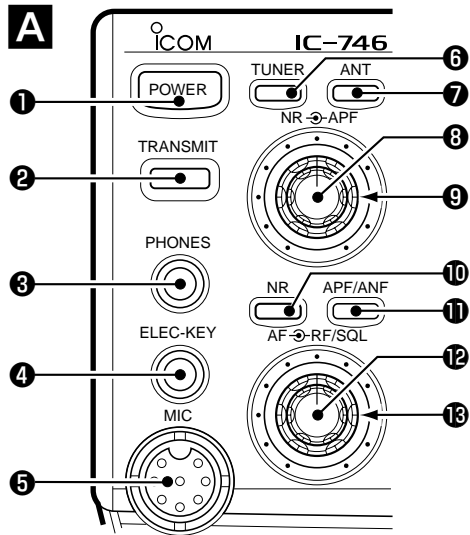
**1 POWER SWITCH [POWER]**

- ➔ Push momentarily to turn power ON. (p. 11)
 - Turn the optional DC power supply ON in advance.
- ➔ Push and hold to turn power OFF.

2 TRANSMIT SWITCH [TRANSMIT]

- Toggles between transmit and receive.
- The [TX] indicator lights red while transmitting and the [RX] indicator lights green when the squelch is open.

3 HEADPHONE JACK [PHONES] (p. 67)

- Accepts headphones.
- When headphones are connected, the internal speaker or connected external speaker does not function.

4 ELECTRONIC KEYS JACK [ELEC-KEY] (p. 67)

- Accepts a paddle to activate the internal electronic keyer for CW operation.
- Selection between the internal electronic keyer, bug-key and straight key operation can be made in keyer set mode.
- A straight key jack is separately available on the rear panel.
- Key polarity (dot and dash) can be reversed in keyer set mode.
- 4-channel memory keyer is available for your convenience.

5 MICROPHONE CONNECTOR [MIC]

- Accepts the supplied or optional microphone.
- See p. 85 for appropriate microphones.
- See p. 67 for microphone connector information.

6 ANTENNA TUNER SWITCH [TUNER] (p. 59)

- ➔ Turns the antenna tuner ON and OFF (bypass) when pushed momentarily.
- ➔ Starts to tune the antenna manually when pushed for 2 sec.

- When the tuner cannot tune the antenna, the tuning circuit is bypassed automatically after 20 sec.

7 ANTENNA SELECTOR SWITCH [ANT] (p. 71)

- Toggles between the HF and 50 MHz antenna connectors.

8 NOISE REDUCTION LEVEL CONTROL [NR] (p. 40)

- Adjusts the noise reduction level when the noise reduction function is in use. Set for maximum readability.

9 AUDIO PEAK FILTER CONTROL [APF] (p. 20)

- Varies the peak frequency of the audio peak filter to pick out a CW signal from interference while the APF function is ON.

10 NOISE REDUCTION SWITCH [NR] (p. 40)

- Toggles the noise reduction function ON and OFF. Functions in SSB, CW and RTTY modes.

11 AUDIO PEAK FILTER/AUTO NOTCH SWITCH [APF/ANF]

- ➔ Toggles between the audio peak (p.20) and auto notch (p. 40) functions.
 - The audio peak filter functions in CW mode only; the auto notch functions in SSB, FM and AM modes only.
 - The APF or ANF indicator appear in the display depending on which function is selected.
- ➔ When the APF indicator appears, push this switch for 1 sec., one or more times to select 320 Hz, 160 Hz or 80 Hz bandwidths.
 - Use the [APF] control to vary the peak frequency.

12 AF CONTROL [AF] (inner control; p. 12)

- Varies the audio output level from the speaker.

- 13 RF GAIN/SQUELCH CONTROL [RF/SQL]** (p. 12)
 Adjusts the RF gain and squelch threshold level. The squelch removes noise output from the speaker (closed condition) when no signal is received.
- The squelch is particularly effective for FM. It is also available for other modes.
 - The control can be set as the RF gain control only (squelch is fixed open) or squelch control (RF gain is fixed at maximum) in set mode.

• Setting RF gain

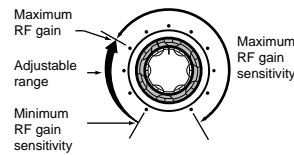

• Setting squelch

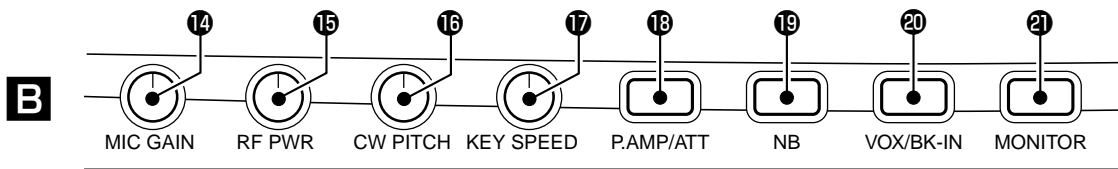
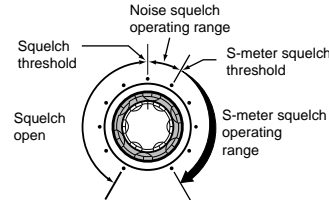

- 14 MIC GAIN CONTROL [MIC GAIN]**
 Adjusts the microphone input gain.
- 15 RF POWER CONTROL [RF PWR]** (p. 84)
 Continuously varies the RF output power from minimum (2 W*) to maximum (100 W*).
- *AM mode: 2–40 W, other modes: 5–100 W.
- 16 CW PITCH CONTROL [CW PITCH]** (p. 20)
 Shifts the received CW audio pitch and monitored CW audio pitch without changing the operating frequency.
- The pitch can be changed from 300 to 900 Hz in approx. 3 Hz steps.

- 17 ELECTRONIC CW KEYSER SPEED CONTROL [KEY SPEED]** (p. 22)
 Adjusts the internal electronic CW keyer's speed.
- 6 wpm to 60 wpm can be set.

- 18 PREAMP/ATTENUATOR SWITCH [P.AMP/ATT]** (p. 38)
 ➔ Push momentarily to toggle between preamp-1 and preamp-2.
 ➔ Push for 1 sec. to toggle the attenuator function ON and OFF.

- 19 NOISE BLANKER SWITCH [NB]** (p. 39)
 Toggles the noise blanker ON and OFF. The noise blanker reduces pulse-type noise such as that generated by automobile ignition systems. This function cannot be used for FM, or non pulse-type noise.

- 20 VOX/BREAK-IN SWITCH [VOX/BK-IN]**
 ➔ In SSB, AM and FM modes, push momentarily to

turn the VOX function ON; push for 1 sec. to turn the VOX function OFF. (p. 43)
 ➔ In CW mode, push momentarily to select semi break-in, full break-in or break-in OFF; push for 2 sec. to enter break-in set mode. (p. 44)

- 21 MONITOR SWITCH [MONI]** (p. 45)
 ➔ Push to toggle the monitor function ON and OFF.
 ➔ Push for 2 sec. to enter and exit monitor set mode.

1 PANEL DESCRIPTION

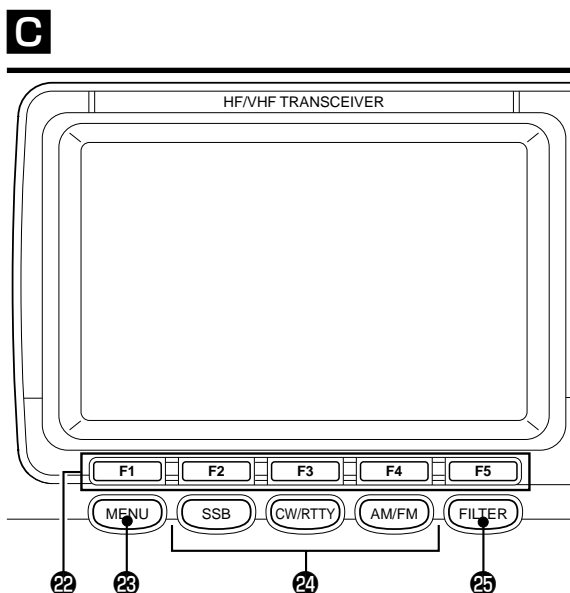
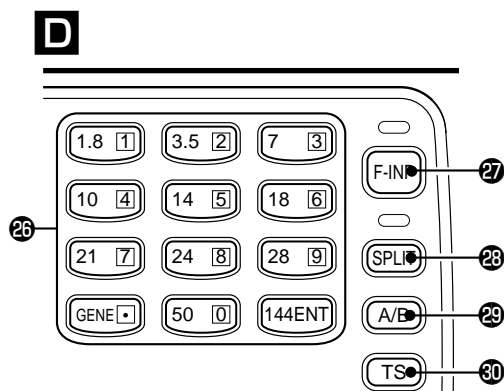
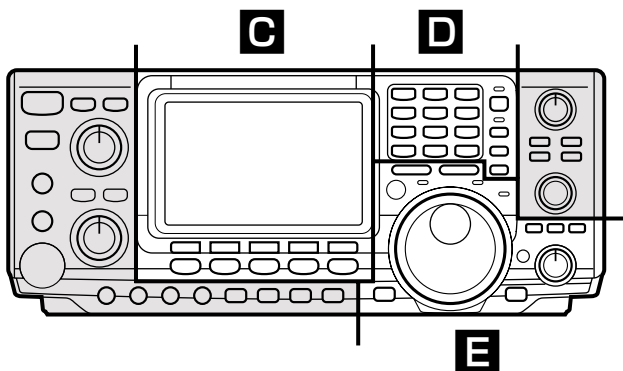

- 22 MULTI-FUNCTION SWITCHES** (p. 8)
 - ➔ Push to select the functions indicated in the function display above these switches.
 - ➔ Push to input a character for memory keyer programming or memory name.
- 23 MENU SWITCH [MENU]** (p. 8)
 - ➔ Push to change the set of functions assigned to the multi-function switches.
 - Toggles between menu set 1 and menu set 2.
- 24 MODE SWITCHES** (p. 17)
 - ➔ Select an operating mode.
 - Push [SSB] to toggle between LSB and USB.
 - Push [CW/RTTY] to toggle between CW and RTTY.
 - Push [CW/RTTY] for 1 sec. to toggle between CW and CW-R or RTTY and RTTY-R.
- 25 FILTER SWITCH** (pgs. 42, 78)
 - ➔ Push momentarily to toggle between normal and narrow IF filters for the selected operating mode.
 - ➔ Push for 1 sec. to enter normal or narrow IF filter set mode.

- 26 KEYPAD** (p. 14)
 - ➔ Push a key to select an operating band.
 - [GENE] selects the general coverage band.
 - ➔ Push the same key 2 or 3 times to call up stacked frequencies in the band.
 - Icom's band stacking register memorizes 3 frequencies (and modes) in each band.
- 27 FREQUENCY INPUT SWITCH [F-INP]** (p. 17)
 - ➔ Toggles keypad input between frequency and band.
 - The LED lights green to indicate the switch is set for frequency input.
- 28 SPLIT SWITCH [SPLIT]** (p. 47)
 - ➔ Push to toggle the split function ON and OFF.
 - The LED lights green to indicate split operation (between VFO A and VFO B is selected).
- 29 A/B SWITCH [A/B]** (p. 13)
 - ➔ Push to toggle between VFO A and VFO B.
 - ➔ Push for 1 sec. to equalize the contents of VFO A and VFO B.
- 30 QUICK TUNING STEP SWITCH [TS]** (p. 15)
 - ➔ Turns the quick tuning step ON and OFF.
 - While the quick tuning indicator is displayed, the frequency can be changed in programmed kHz steps.
 - 1, 5, 9 and 10 kHz quick tuning steps are available.
 - ➔ While the quick tuning step is OFF, turns the 1 Hz step ON and OFF when pushed for 2 sec.
 - 1 Hz indications appear in both readouts and the frequency can be changed in 1 Hz steps.
 - ➔ While the quick tuning step is ON, enters the quick tuning step mode when pushed for 2 sec.

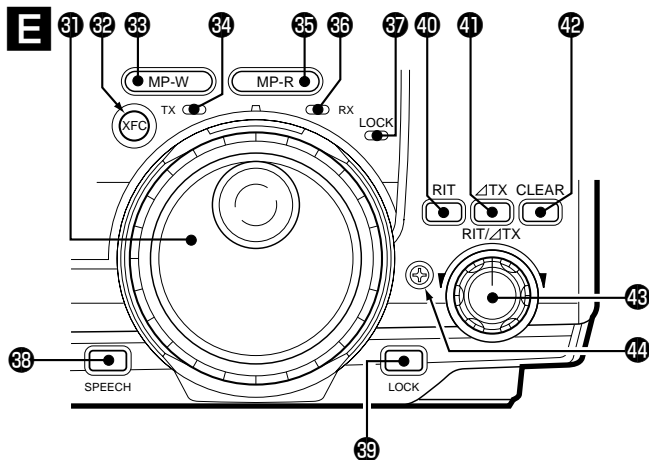

31 TUNING DIAL

Changes the displayed frequency, selects set mode items, etc.

32 TRANSMIT FREQUENCY CHECK SWITCH [XFC]

(pgs. 34, 38, 45, 47)
Monitors the transmit frequency when pushed and held when the split frequency function is ON.

- While pushing this switch, the transmit frequency can be changed with the tuning dial, keypad or the memo pad.
- When the split lock function is turned ON, pushing [XFC] cancels the dial lock function.

33 MEMO PAD WRITE SWITCH [MP-W] (p. 54)

Programs the selected readout frequency and operating mode into a memo pad.

- The 5 most recent entries remain in memo pads.
- The transmit frequency is programmed when pushed together with [XFC].
- The memo pad capacity can be expanded from 5 to 10 in set mode for your convenience.

34 TRANSMIT INDICATOR [TX]

Lights red while transmitting.

35 MEMO PAD READ SWITCH [MP-R] (p. 54)

Each push calls up a frequency and operating mode in a memo pad. The (or 10) most recently programmed frequencies and operating modes can be recalled, starting from the most recent.

- The memo pad capacity can be expanded from 5 to 10 in set mode for your convenience.

36 RECEIVE INDICATOR [RX]

Lights green while receiving a signal or when the squelch is open.

37 LOCK INDICATOR [LOCK] (p. 40)

Lights when the dial lock function is activated.

38 SPEECH SWITCH [SPEECH] (p. 77)

Announces the selected readout frequency when an optional UT-102 is installed.

39 LOCK SWITCH [LOCK] (p. 40)

Turns the dial lock function ON and OFF.

40 RIT SWITCH [RIT] (p. 38)

Turns the RIT function ON and OFF when pushed.

- Use the [RIT/ΔTX] control to vary the RIT frequency.
- Adds the RIT shift frequency to the operating frequency when pushed for 2 sec.

41 ΔTX SWITCH [ΔTX] (p. 45)

Turns the ΔTX function ON and OFF when pushed.

- Use the [RIT/ΔTX] control to vary the ΔTX frequency.
- Adds the ΔTX shift frequency to the operating frequency when pushed for 2 sec.

42 CLEAR SWITCH [CLEAR] (pgs. 38, 45)

Clears the RIT/ΔTX shift frequency when pushed for 2 sec.

43 RIT/ΔTX CONTROL [RIT/ΔTX] (pgs. 38, 45)

Shifts the receive and/or transmit frequency without changing the transmit and/or receive frequency while the RIT and/or ΔTX functions are ON.

- Rotate the control clockwise to increase the frequency, or rotate the control counterclockwise to decrease the frequency.
- The shift frequency range is ±9.999 kHz in 1 Hz steps (or ±9.99 kHz in 10 Hz steps).

44 BRAKE ADJUSTMENT SCREW (p. 65)

Adjusts the tension of the tuning dial.

- Rotate clockwise to increase the tension; counterclockwise to decrease the tension.

1 PANEL DESCRIPTION

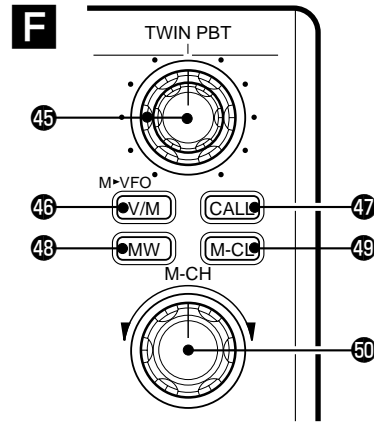
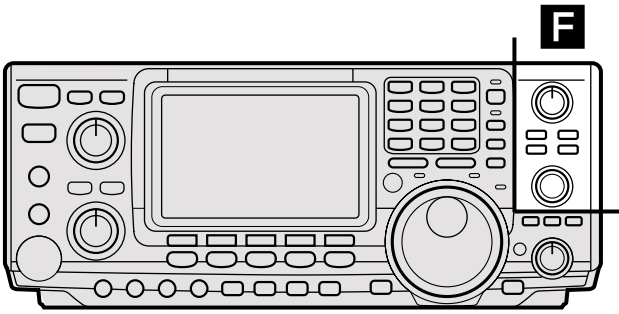

45 PASSBAND TUNING CONTROLS [TWIN PBT]

(p. 41)

Adjust the receiver's "passband width" of the 455 kHz and 9 kHz IF filters for the inner and outer controls, respectively.

- Passband width and center frequency are displayed in the function display.
- Set to the center positions when not in use.
- Variable range depends on the filter selection. ± 1.29 kHz in 15 Hz steps and ± 258 Hz in 3 Hz steps are available.

46 VFO/MEMORY SWITCH [V/M]

- ➔ Toggles the selected readout operating mode between VFO mode and memory mode when pushed.
- ➔ Transfers the memory contents to VFO when pushed for 2 sec.

47 CALL CHANNEL SWITCH [CALL] (p. 51)

Brings up the call channel.

- When the call channel is displayed, push this switch to exit call channel mode.

48 MEMORY WRITE SWITCH [MW] (p. 51)

Stores the selected readout frequency and operating mode into the displayed memory channel when pushed for 2 sec.

- This function is available in both VFO and memory modes.

49 MEMORY CLEAR SWITCH [M-CL] (p. 50)

Clears the selected readout memory channel contents when pushed for 2 sec. in memory mode.

- This switch does not function in VFO mode.

50 MEMORY CHANNEL CONTROL [M-CH] (p.49)

Selects a memory channel.

- Rotate clockwise to increase the memory channel; rotate counterclockwise to decrease the memory channel.

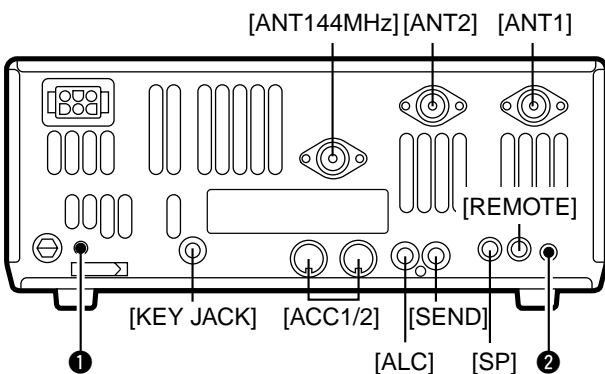

1-2 Rear panel

1 CALIBRATION POT [CAL]

This is used for frequency calibration (p. 65).

- The transceiver has been adjusted and calibrated thoroughly at the factory. Under normal circumstances, the frequency does not need to be recalibrated.

2 COMPRESSION LEVEL CONTROL [COMP GAIN] (p. 46)

Adjusts the speech compression level in SSB.

☞ **NOTE:** Refer to "12-2 Rear panel" (p. 68) for details concerning other rear panel connectors, etc.

1-3 Function display

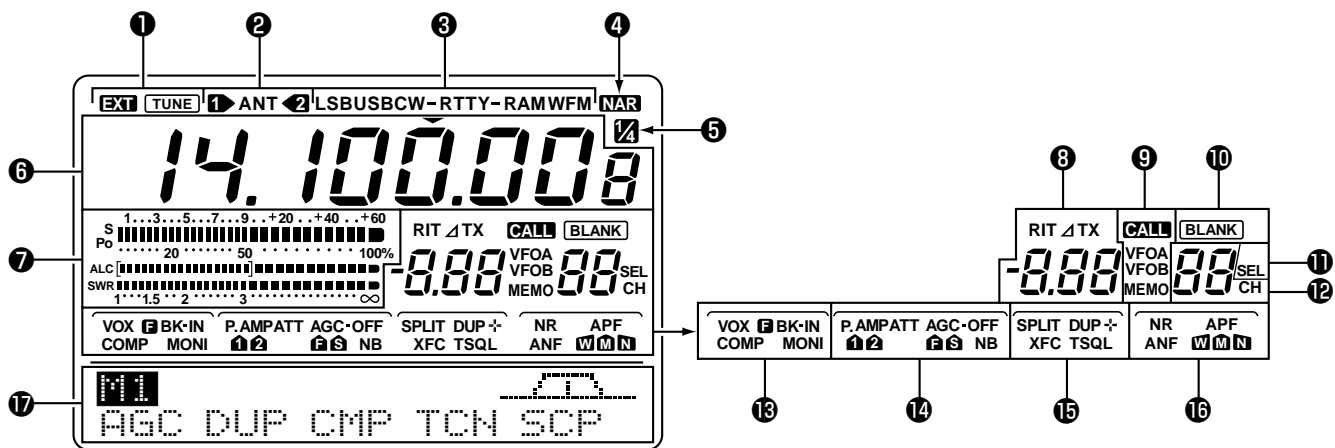

- 1 ANTENNA TUNER INDICATORS** (pgs. 59, 79)
 - ↳ “TUNE” appears when the antenna tuner is ON; “TUNE” appears and flashes during manual tuning.
 - ↳ “EXT” appears when the optional AH-4 external HF antenna tuner is connected to [ANT1].
- 2 ANTENNA INDICATORS** (p. 71)

Indicate which antenna connector is in use for HF/50 MHz.
- 3 MODE INDICATORS** (p. 7)

Indicate the selected operating mode.
- 4 NARROW FILTER INDICATOR** (p. 42)

Appears when the narrow IF filter is selected.
- 5 ¼ TUNING DIAL SPEED INDICATOR** (p. 39)

Appears when the tuning dial is set so that one revolution is equal to ¼ of the normal revolution.
- 6 FREQUENCY READOUT**

Shows the operating frequency.
- 7 MULTI-FUNCTION METER INDICATION**

Displays S-meter reading during receive; “Po,” “ALC” and “SWR” meters can be selected for transmit.
- 8 RIT/ΔTX INDICATORS** (pgs. 38, 45)

Appear during RIT or ΔTX operation and indicate the frequency offset.
- 9 VFO/CALL/MEMORY INDICATORS**

Indicate whether VFO A, VFO B, the call channel or memory mode is selected.
- 10 BLANK MEMORY INDICATOR** (p. 49)

Appears when the selected memory channel is blank.
- 11 SELECT MEMORY INDICATOR** (p. 57)

Appears when the selected memory channel is a “select” memory channel.
- 12 MEMORY CHANNEL INDICATOR** (p. 49)

Shows the selected memory channel.
- 13 TRANSMIT FUNCTION INDICATORS**

Indicate functions selected for transmit.
- 14 RECEIVE FUNCTION INDICATORS**

Indicate functions selected for receive.
- 15 SPLIT FUNCTION INDICATOR**

Appears during split operation.
- 16 DSP FUNCTION INDICATORS**

Appear when DSP functions are selected.
- 17 MULTI-FUNCTION SWITCH INDICATORS** (p. 8)

Indicate the functions assigned to the multi-function switches (F1–F5).

MENU SELECTION

Pushing [MENU] toggles between menu set 1 (M1) and menu set 2 (M2) in the function display.

Depending on the mode and menu item selected, the action of the multi-function keys ([F1] to [F5]) changes.

2-1 Menu set 1 flow chart

SSB MODE

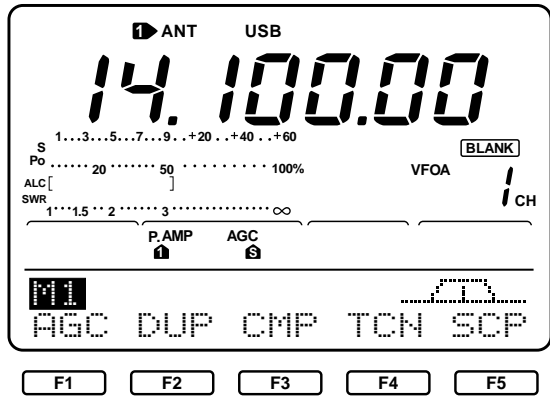

TONE CONTROL MENU



RTTY MODE

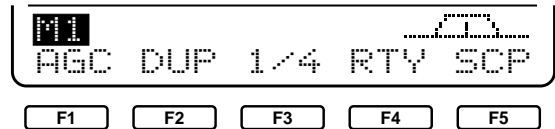

RTTY MENU

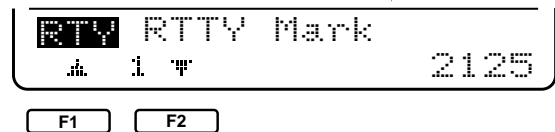

AM MODE

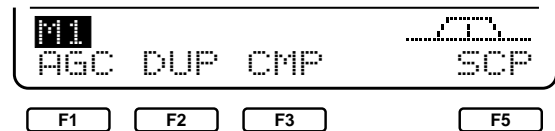

CW MODE

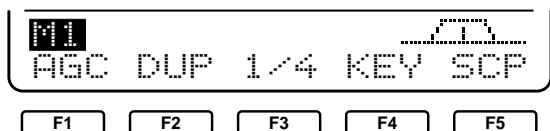

MEMORY KEYER MENU

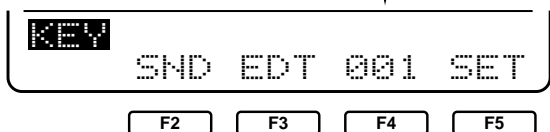

SEND MENU

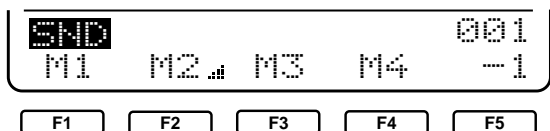

FM MODE

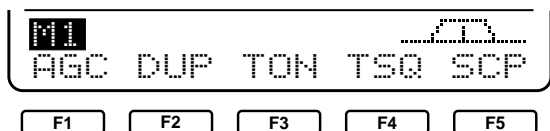

BAND SCOPE MENU

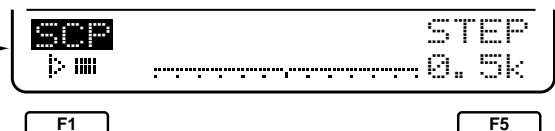

EDIT MENU

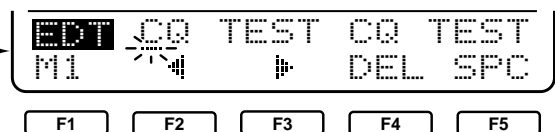

CONTEST NUMBER MENU

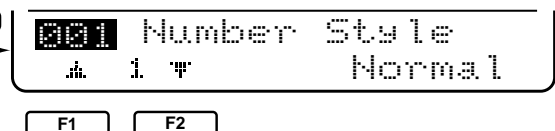

KEYER SET MODE



To band scope menu

2-2 Menu set 2 flow chart

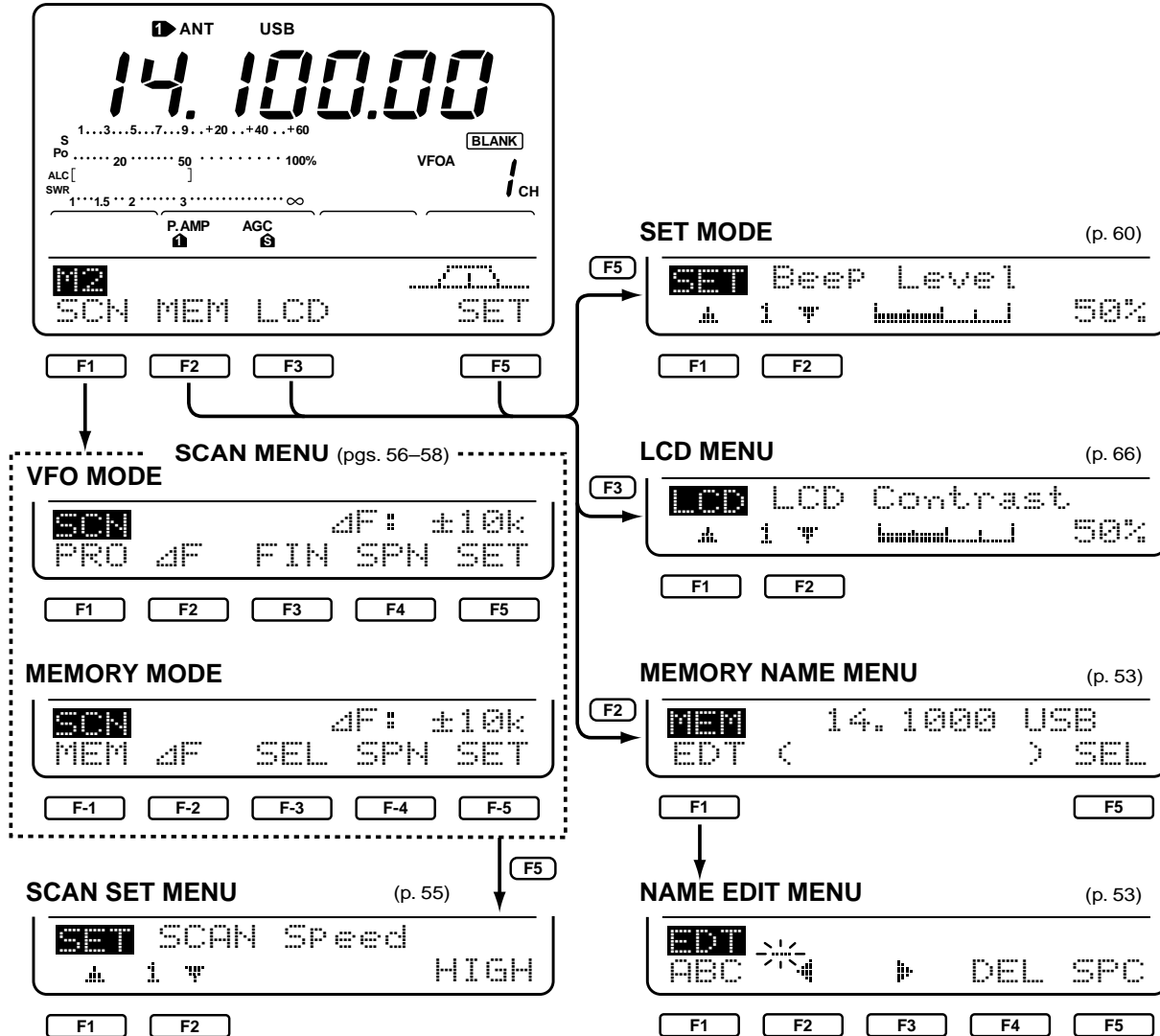

MENU	MODE	F1	F2	F3	F4	F5
	SSB	① AGC	② DUP	③ CMP	④ TCN	⑤ SCP
	CW	AGC	DUP	⑥ 1/4	⑦ KEY	SCP
M1	RTTY	AGC	DUP	1/4	⑧ RTY	SCP
	AM	AGC	DUP	CMP		SCP
	FM	AGC	DUP	⑨ TON	⑩ TSQ	SCP
M2	ALL	⑪ SCN	⑫ MEM	⑬ LCD		⑭ SET

- ① AGC (auto gain control) : p. 39
- ② DUP (duplex) : p. 35
- ③ CMP (speech compressor) : p. 46
- ④ TCN (tone control) : p. 20
- ⑤ SCP (band scope) : p. 37
- ⑥ 1/4 (dial rate) : p. 39
- ⑦ KEY (CW key) : p. 24
- ⑧ RTY (RTTY) : p. 30
- ⑨ TON (repeater tone) : p. 35
- ⑩ TSQ (tone squelch) : p. 33
- ⑪ SCN (scan) : p. 55
- ⑫ MEM (memory names) : p. 53
- ⑬ LCD (function display) : p. 66
- ⑭ SET (set mode) : p. 60

3-1 Before operating

A BEFORE APPLYING POWER

Before applying power for the first time, check the following points:

- ➔ Is the connected external power supply capable of delivering more than 20 A?
- ➔ Are the antenna(s) connected properly?
 - [ANT1/2]: HF/50 MHz antenna
 - [144MHz]: 144 MHz antenna
- ➔ Is the transceiver properly grounded? (p. 70)
- ➔ Is external equipment, such as a linear amplifier connected properly? (p. 79)
- ➔ Make sure the front panel switches and controls are set as illustrated below.

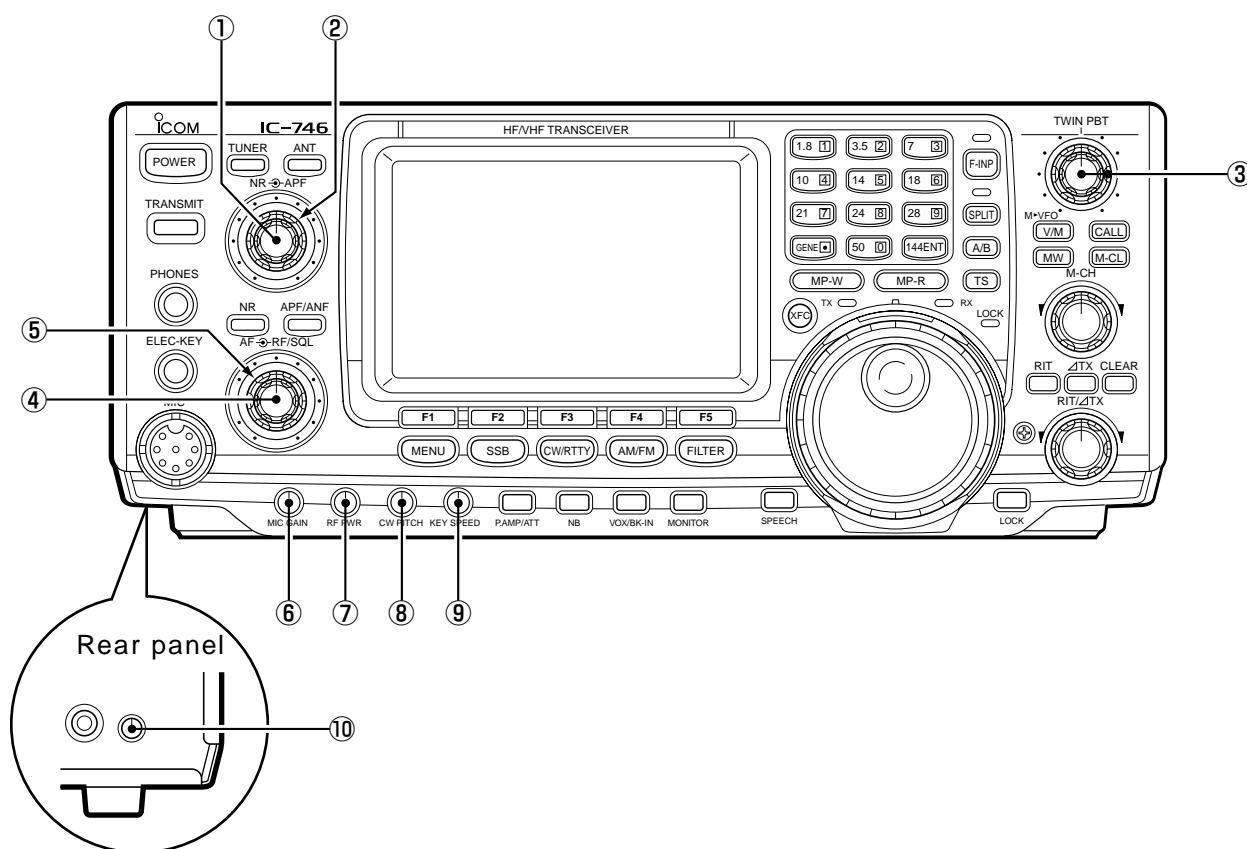

- ① Rotate [NR] max. counterclockwise.
- ② Set [APF] to the center position.
- ③ Set [TWIN PBT] to the center position.
- ④ Rotate [AF] max. counterclockwise.
- ⑤ Set [RF/SQ] to the center position.
- ⑥ Rotate [MIC GAIN] max. counterclockwise.
- ⑦ Rotate [RF PWR] max. counterclockwise.
- ⑧ Set [CW PITCH] to the center position.
- ⑨ Rotate [KEY SPEED] max. counterclockwise.
- ⑩ Rotate [COMP GAIN] max. counterclockwise.

B APPLYING POWER

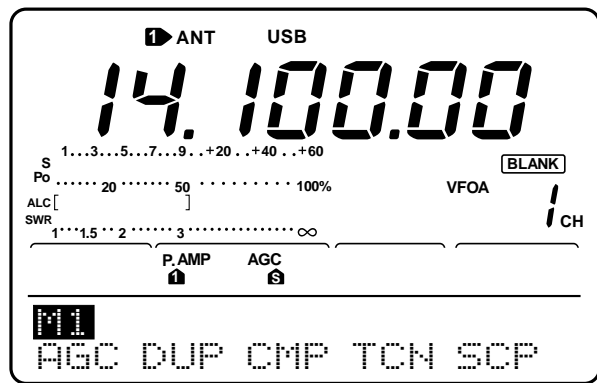
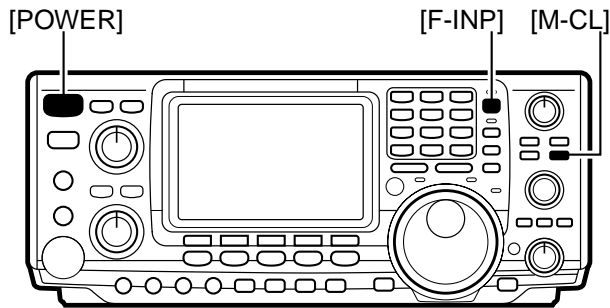

When applying power to the transceiver for the first time, it's a good idea to reset the CPU (see p. 81 for details) as follows:

While pushing [F-INP] + [M-CL], push [POWER] to turn power ON.

- After the CPU has been reset, turn power ON by pushing [POWER] only.
- Push [POWER] for 1 sec. to turn power OFF.

NOTE: When first applying power or when operating in cold environments, the display may flicker or appear faint. This is normal and will disappear once the transceiver has warmed up.

C ADJUSTING VOLUME

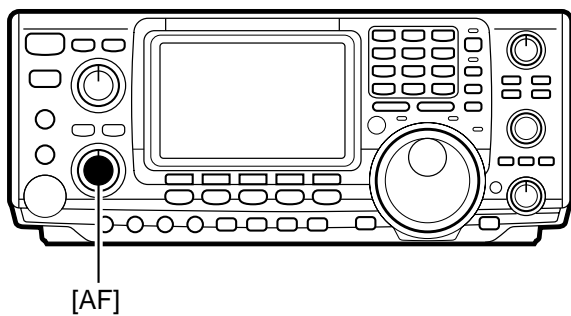

Rotate [AF] to obtain a comfortable listening level.

- Clockwise rotation increases audio output; counterclockwise decreases audio output.



3-2 Squelch and receive (RF) sensitivity

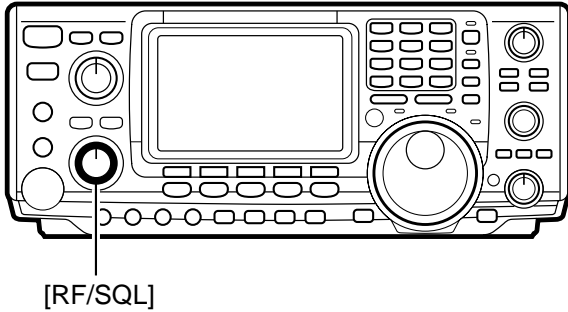

When setting as RF gain/squelch control

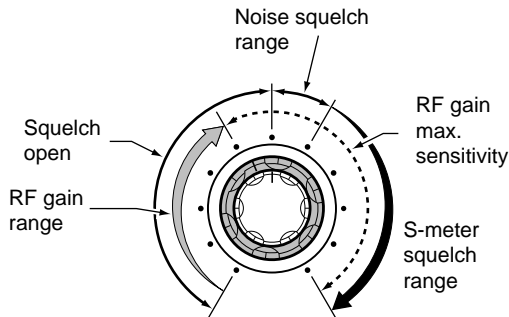

When setting as RF gain (squelch is fixed open)

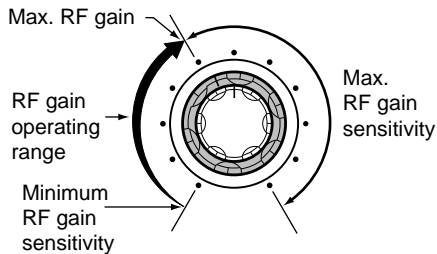

When setting as squelch (RF gain is fixed at max.)

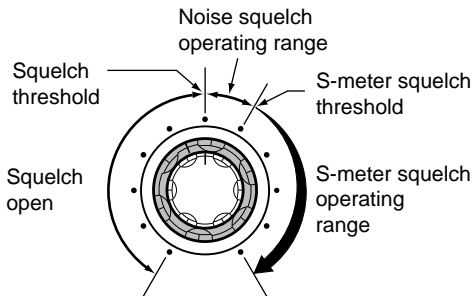

Adjusts the RF gain and squelch threshold level. The squelch removes noise output from the speaker (closed condition) when no signal is received.

- The squelch is particularly effective for FM. It is also available for other modes.
- The control can be set as the RF gain control only (squelch is fixed open) or squelch control (RF gain is fixed at maximum) in set mode (p. 61). See below left.
- The 11 to 12 o'clock position is recommended for any setting of the [RF/SQL] control.

SET MODE	OPERATION
RF + SQL (default)	Can be used in all modes. Functions as noise squelch or S-meter squelch in FM; S-meter squelch only in other modes.
SQL	➔ Operates as a squelch control. <ul style="list-style-type: none"> • RF gain is fixed at max. sensitivity.
RF	➔ Operates as an RF gain control. <ul style="list-style-type: none"> • Squelch is fixed open.

Adjusting RF gain (receive sensitivity)

Normally, [RF/SQL] is set to the 11 o'clock position. Rotate [RF/SQL] to the 11 o'clock position for maximum sensitivity.

- Rotating counterclockwise from the maximum position reduces sensitivity.
- The S-meter indicates receive sensitivity.

Adjusting squelch (removing non-signal noise)

Rotate [RF/SQL] clockwise, when receiving no signal, until the noise just disappears.

- [RX] indicator light goes out.
- Rotating [RF/SQL] past the threshold point invokes the S-meter squelch—this allows you to set a minimum signal level needed to open the squelch.

3-3 Selecting VFO/memory mode

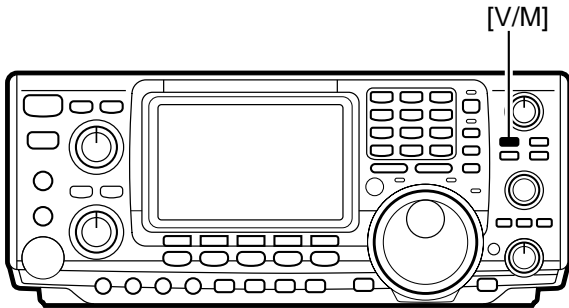

Rotating the tuning dial selects frequencies in VFO mode or pre-programmed memories in memory mode.

Push [V/M] to toggle between memory and VFO modes.

- Pushing [V/M] for 2 sec. transfers the contents of the selected memory channel to VFO mode (p. 50).

■ VFO DISPLAY (default)

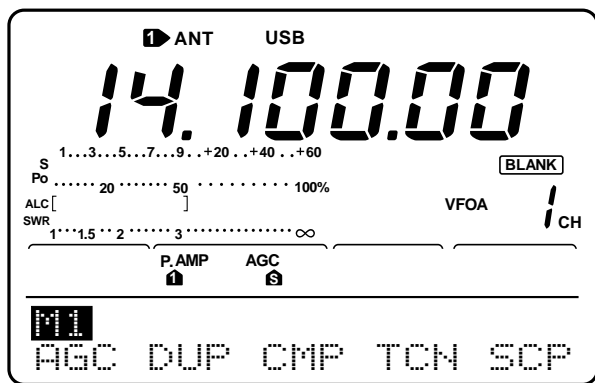

■ MEMORY DISPLAY (default)

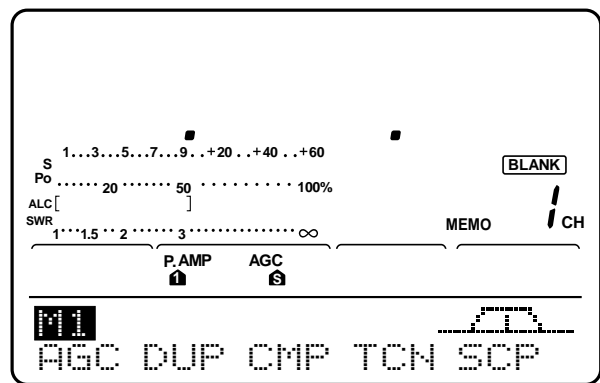

3-4 Toggling between VFO A/B and transferring contents

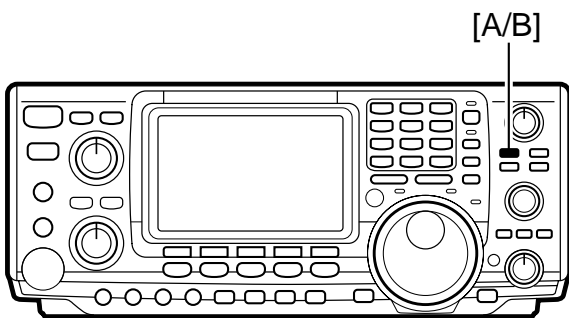

In VFO mode, VFO A or VFO B can be selected. In addition, contents can be transferred between them.

- ➔ Push [A/B] to toggle between VFO A and VFO B.
- ➔ Push [A/B] for 1 sec. to transfer the contents of the displayed VFO to the undisplayed VFO.

■ WHEN OPERATING IN VFO A

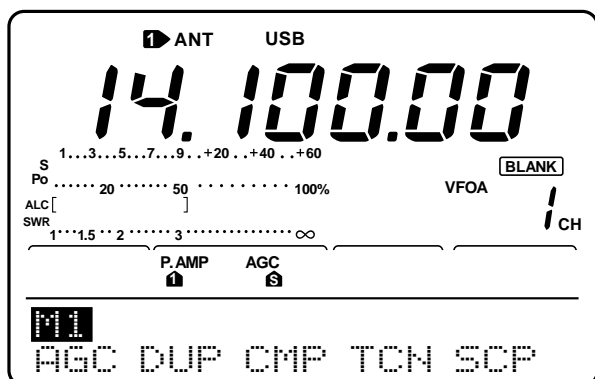

■ WHEN OPERATING IN VFO B

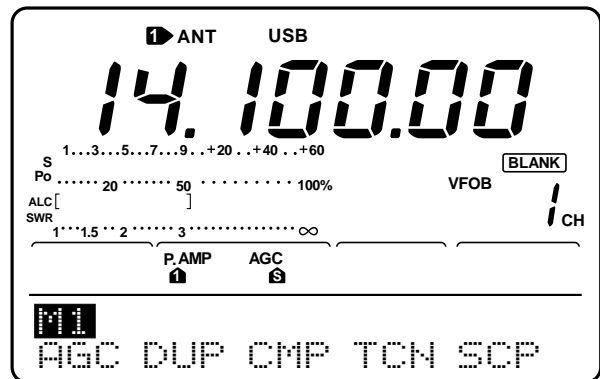

3 BASIC OPERATION

3-5 Setting a band and frequency

▲ SETTING AN OPERATING BAND

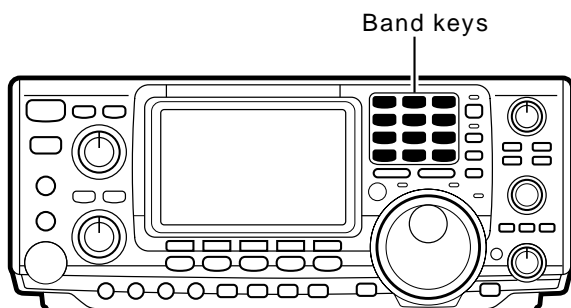

The transceiver has a triple band stacking register. This means that the last 3 operating frequencies and modes used on a particular band are automatically memorized.

See the table below for a list of the bands available and the default settings for each register.

BAND	REGISTER 1	REGISTER 2	REGISTER 3
1.9 MHz	1.900000 CW	1.910000 CW	1.915000 CW
3.5 MHz	3.550000 LSB	3.560000 CW	3.580000 LSB
7 MHz	7.050000 LSB	7.060000 CW	7.020000 CW
10 MHz	10.120000 CW	10.130000 CW	10.140000 CW
14 MHz	14.100000 USB	14.200000 USB	14.050000 CW
18 MHz	18.100000 USB	18.130000 USB	18.150000 USB
21 MHz	21.200000 USB	21.300000 USB	21.050000 CW
24 MHz	24.950000 USB	24.980000 USB	24.900000 CW
28 MHz	28.500000 USB	29.500000 USB	28.100000 CW
50 MHz	50.100000 USB	50.200000 USB	51.100000 FM
145 MHz	145.000000 USB	145.100000 FM	145.200000 FM
General	15.000000 USB	15.100000 USB	15.200000 USB

■ USING THE BAND STACKING REGISTERS

[EXAMPLE]: 21 MHz band

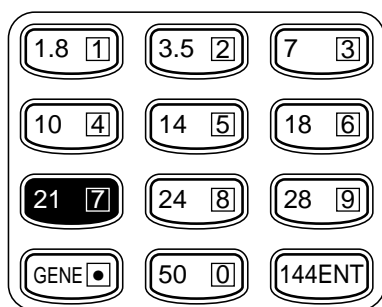

- ① Push [21⁷], then select a frequency and an operating mode.
 - Frequency and operating mode are memorized in the first band stacking register.
- ② Push [21⁷] again, then select another frequency and operating mode.
 - This frequency and operating mode are memorized in the second band stacking register.
- ③ Push [21⁷] again, then select another frequency and operating mode.
 - This frequency and operating mode are memorized in the third band stacking register.
 - When a fourth frequency and operating mode are selected on a band, the first register is overwritten.

B SETTING A FREQUENCY WITH THE TUNING DIAL

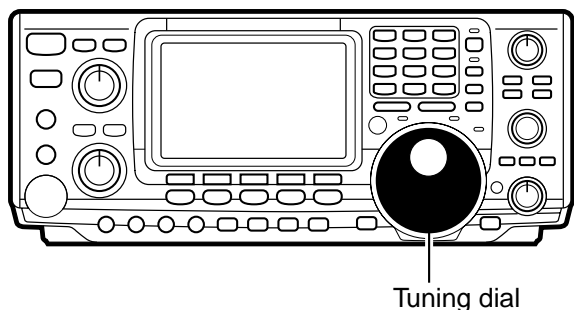

Frequencies can be selected with the tuning dial or directly with the keypad (p. 17). When using the tuning dial, the frequency changes according to the set tuning step. Tuning step defaults differ depending on operating mode as shown below.

SSB/CW/RTTY: 10 Hz

AM: 1 kHz

FM: 10 kHz

➔ Rotate the tuning dial clockwise to increase the frequency; counterclockwise to decrease the frequency.

■ BAND EDGE WARNING BEEPS

When selecting a frequency that lies outside of a band's specified frequency range, a warning beep sounds.

This function can be turned off in set mode, if desired (p. 61).

■ AUTO TUNING STEPS

Tuning steps automatically change according to the rate at which the tuning dial is rotated.

When rotated slowly, one complete revolution of the tuning dial changes the frequency 5 kHz (10 Hz tuning steps); when rotated quickly, one complete revolution of the tuning dial changes the frequency 25 kHz (50 Hz tuning steps).

■ CHANGING TUNING STEPS

Rotate the tuning dial to change the frequency in 10 Hz steps or use the microphone [UP]/[DN] keys to change the frequency in 50 Hz steps. The diagram below illustrates how to change the tuning steps.

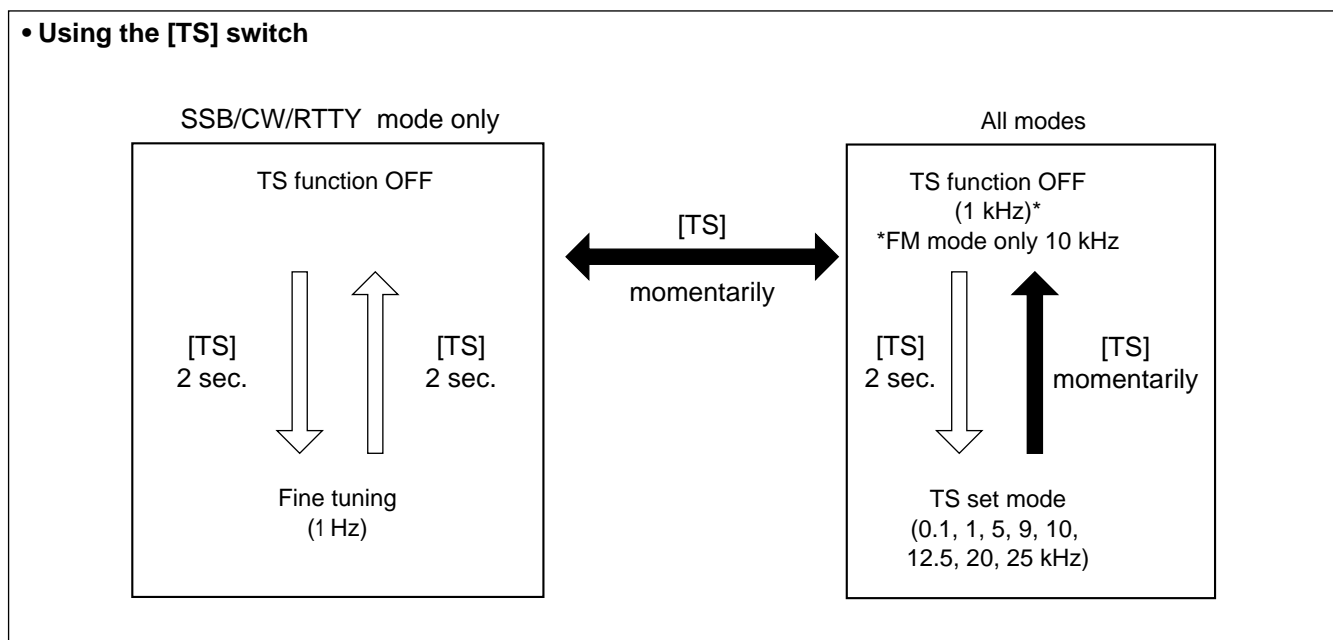

3 BASIC OPERATION

■ TOGGLING THE TS FUNCTION ON AND OFF

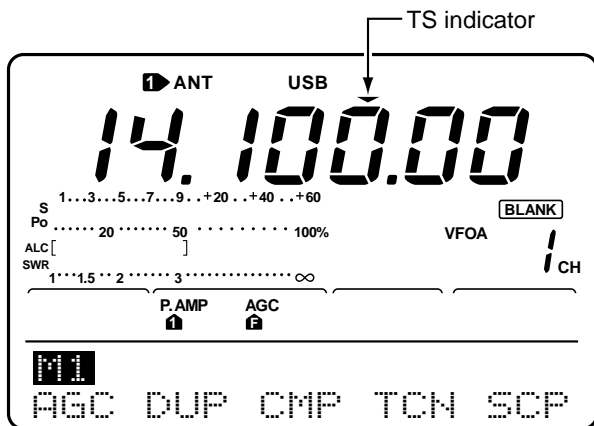
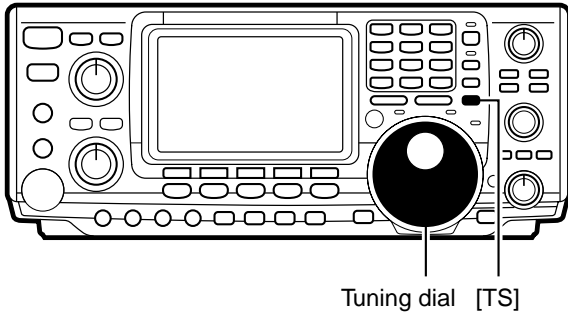

The tuning step function can be turned ON and OFF. When the TS function is ON (default), rotating the tuning dial changes the frequency in the set tuning steps.

- ① Push [TS] to turn the tuning step function ON, if necessary.
 - The TS indicator, “▼” appears.
- ② Rotate the tuning dial to change the frequency according to the set tuning step.
- ③ Push [TS] again to turn the tuning step function OFF.
 - The TS indicator, “▼” disappears.

The tuning step defaults are:

SSB/CW/RTTY: 10 Hz
 AM: 1 kHz
 FM: 10 kHz

■ TUNING STEP PROGRAM MODE

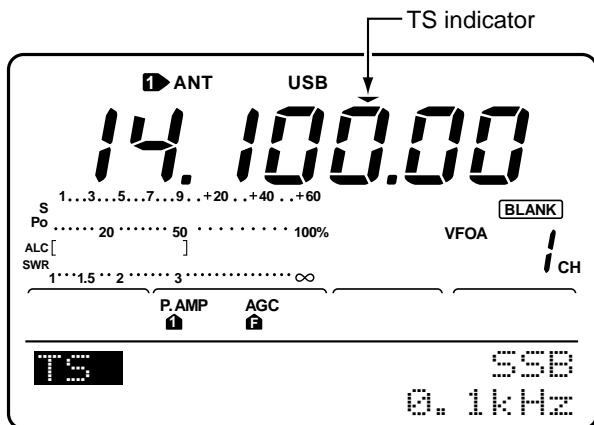

When the tuning step function is ON, tuning step program mode can be selected. This mode is used to change the set tuning steps.

- ① While the tuning step function is ON, (“▼” appears), push [TS] for 2 sec. to enter tuning step program mode.
- ② Rotate the tuning dial to select the desired tuning step.
 - 0.1, 1, 5, 9, 10, 12.5, 20 and 25 kHz can be selected.
 - Tuning steps can be set individually for each operating mode.
- ③ Push [TS] again to exit tuning step program mode.

■ 1 Hz TUNING

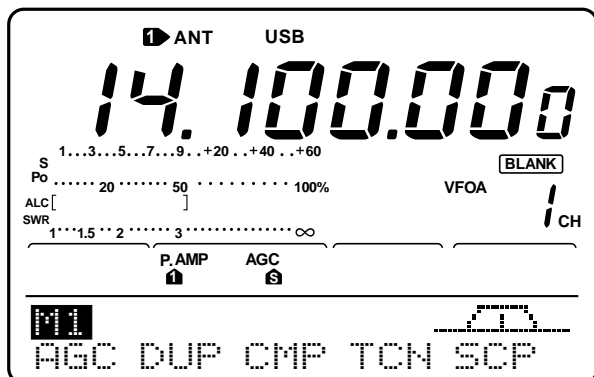

For critical tuning, a 1 Hz tuning step can be selected.

- ① While the tuning step function is OFF, (“▼” does not appear), push [TS] for 2 sec.
 - The 1 Hz indicator appears.
- ② Rotate the tuning dial to change the frequency in 1 Hz steps.
 - When changing the frequency via the microphone, the frequency changes in 50 Hz steps, regardless of whether the 1 Hz tuning step is selected or not.
- ③ Push [TS] for 2 sec. again (while the tuning step function is OFF) to turn the 1 Hz tuning step OFF.

SETTING A FREQUENCY VIA THE KEYPAD

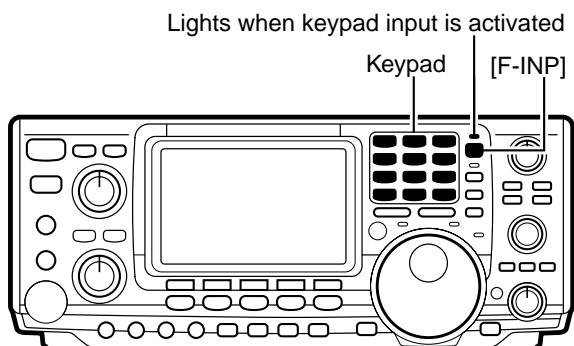

The keypad can be used to enter frequencies directly.

- ① Push [F-INP] to activate keypad input.
- ② Enter the desired frequency using the corresponding digit keys on the keypad.
 - The displayed frequency is cleared and input starts at the far right of the frequency display.
 - Input “.” (decimal point) between the MHz units and kHz units.
 - Push [F-INP] to cancel input and return to the previous frequency.
- ③ When the desired frequency is input, push [144ENT] to set the displayed frequency.

[EXAMPLES]:

Setting 7.000000 MHz

Push [F-INP] + [2][1][7] + [144ENT]

Setting 14.025000 MHz

Push [F-INP] + [1.8][1] + [10][4] + [GENE(•)] + [50][0] + [3.5][2] + [14][5] + [144ENT]

Setting 145.500000 MHz

Push [F-INP] + [1.8][1] + [10][4] + [14][5] + [GENE(•)] + [14][5] + [144ENT]

Setting 145.500000 MHz from 145.360000 MHz

Push [F-INP] + [GENE] + [7][3] + [18][6] + [144ENT]

3-6 Selecting an operating mode

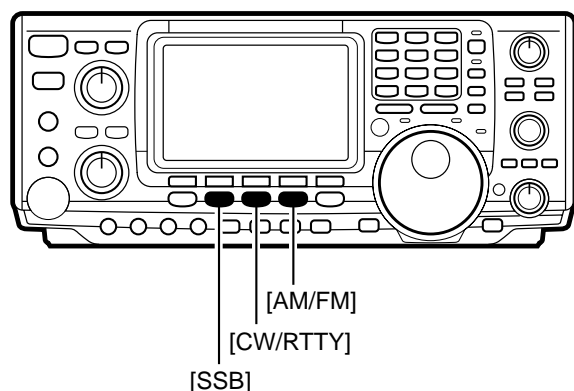

Each push of a mode key changes the operating frequency. In addition, in CW and RTTY modes, pushing [CW/RTTY] for 2 sec. toggles between reverse and normal modes.

SSB mode

Above 10 MHz, USB is automatically selected; below 10 MHz, LSB is automatically selected.

CW mode

Use CW-R mode when nearby BFO frequencies are causing interference.

RTTY mode

When an all mode TNC is connected, RTTY(FSK) operation is possible.

MODE KEY	MOMENTARY PUSH	PUSH FOR 2 SEC.
[SSB]	Toggles between LSB and USB	No function
[CW/RTTY]	Toggles between CW and RTTY	Toggles between CW and CW-R or RTTY and RTTY-R
[AM/FM]	Toggles between AM and FM	No function

4-1 Operating SSB

A RECEIVING

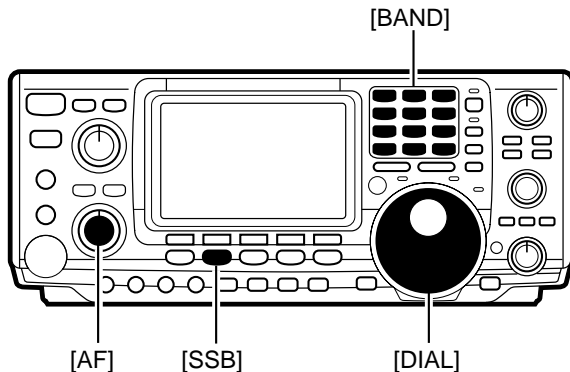

- ① Push a band key to select the desired band.
- ② Push [SSB] to select LSB or USB.
 - Below 10 MHz LSB is automatically selected; above 10 MHz USB is automatically selected.
- ③ Rotate [AF] to set audio to a comfortable listening level.
- ④ Rotate the tuning dial to tune a desired signal.
 - S-meter indicates received signal strength.

✓ Convenient functions for receive

① Preamp and attenuator (p. 38)

The **preamp** amplifies received signals in the front end circuit to improve the S/N ration and sensitivity. The **attenuator** prevents a desired signal from distorting when very strong signals are near the desired frequency or when very strong electric fields, such as from a broadcasting station, are near you.

② Noise blanker (p. 39)

The noise blanker is used to reduce pulse-type noise caused by vehicle ignition systems and key clicks from strong CW signals on nearby frequencies.

③ Noise reduction (p. 40)



The noise reduction function reduces noise components and picks out desired signals which are buried in noise. This function digitally transposes receive audio components to produce desired AF frequency characteristics at the IF stage.

④ Auto notch filter (p. 40)



The auto notch function automatically attenuates more than 3 beat tones, tuning signals, etc., even if they are moving.

⑤ Twin PBT (passband tuning) (p. 41)

The PBT function electronically narrows the receiver's IF passband widths to reduce interference. Moving both [TWIN PBT] controls to the same position shifts the IF.

⑥ AGC (auto gain control) (p. 39)

The AGC controls receiver gain to produce a constant audio output level even when the received signal strength is varied by fading, etc.

B TRANSMITTING

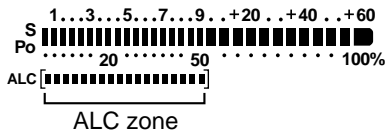
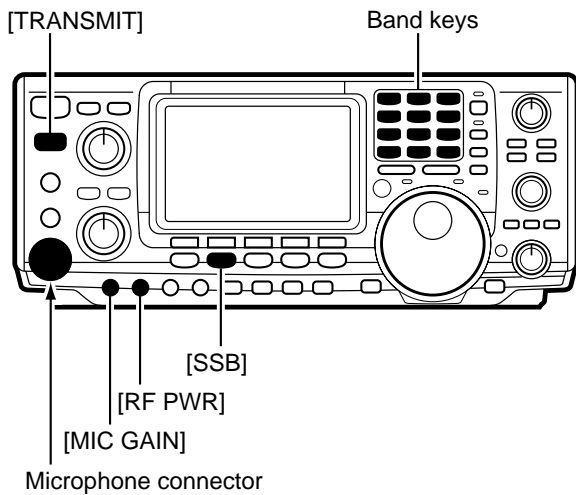

Before transmitting, monitor your selected operating frequency to make sure transmitting won't cause interference to other stations on the same frequency.

- ① Connect the microphone to the [MIC] connector.
- ② Push a band key to select the desired operating band.
- ③ Push [SSB] to select LSB or USB.
- ④ Rotate [RF PWR] to select output power.
- ⑤ Push [TRANSMIT] or [PTT] to transmit.
 - Talk into the microphone at your normal voice level.
 - If necessary, adjust microphone gain with [MIC GAIN] so that the ALC meter reading doesn't go outside the ALC zone (see left).
- ⑥ Push [TRANSMIT] again or release [PTT] to return to receive.

■ ADJUSTING TRANSMIT SIGNAL TONE

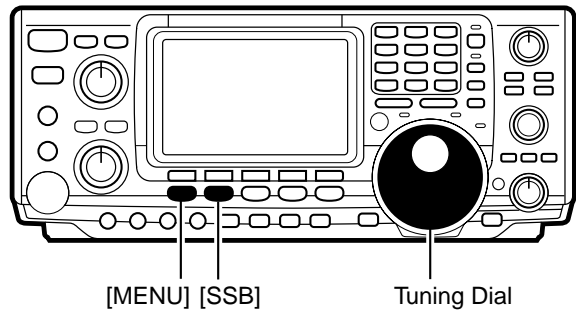

• Tone control menu



The tone of your transmitted signal can be adjusted to suit your preference. In addition, the speech compressor function (p. 46) can be used to increase your talk power.

- ① Push [SSB] to select LSB or USB.
- ② Push [MENU] to select M1.
- ③ Push [F4] to display the tone control menu.
- ④ Push [MONI] to turn the monitor function on.
 - "MONI" appears.
- ⑤ While pushing [PTT] and speaking into the microphone, rotate the tuning dial to vary the tone of your transmitted signal.
 - Clockwise rotation increases the tone; counterclockwise rotation decreases the tone.
- ⑥ Push [MENU] to return to M1.

✓ Convenient functions for transmit

① Speech compressor (p. 46)

The speech compressor compresses the transmitter audio input to increase the average audio output level. Therefore, talk power is increased. This function is effective for long distance communication or when propagation conditions are poor.

② VOX (voice activated transmit) (p. 43)

The VOX function starts transmission without pushing the transmit switch or PTT switch when you speak into the microphone; then, automatically returns to receive when you stop speaking.

③ Transmit quality monitor (p. 45)

This function allows you to monitor the quality of your transmitted signal.

4-2 Operating CW

RECEIVING

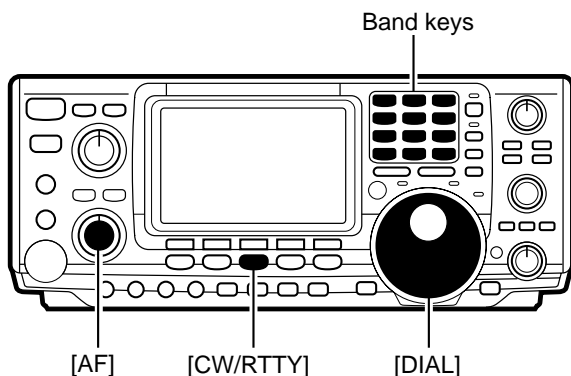

- ① Push a band key to select the desired band.
- ② Push [CW/RTTY] to select CW or CW-R.
 - Push [CW/RTTY] for 2 sec. to toggle between CW and CW-R modes.
- ③ Rotate [AF] to set audio to a comfortable listening level.
- ④ Rotate the tuning dial to simultaneously tune a signal and its side tone.
 - S-meter indicates received signal strength.

ABOUT CW REVERSE MODE

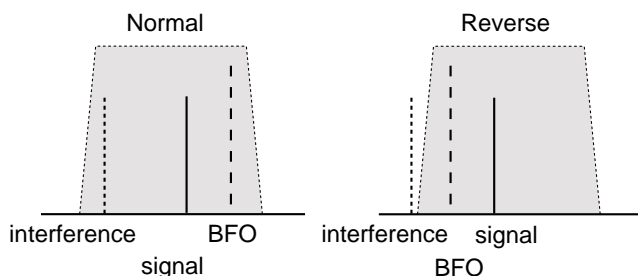

CW reverse mode receives CW signals with a reverse side CW carrier point like that of LSB and USB modes. Use this mode when interfering signals are near the desired signal and you want to change the interference tone.

ABOUT THE AUDIO PEAK FILTER

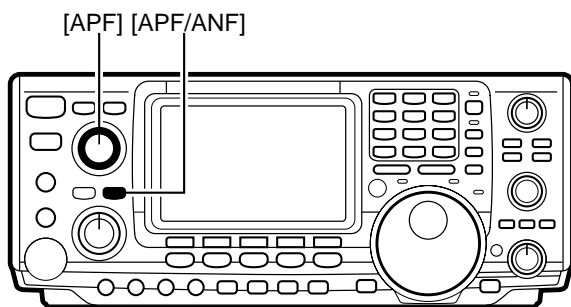

The APF changes the receive frequency response by boosting a particular frequency for better copying of desired CW signals. The peak frequency can be adjusted from 300 to 900 Hz manually. The boost frequency width can be selected from 80, 160 or 320 Hz.

- ① Push [APF/ANF] to turn the audio peak filter ON.
- ② Push [APF/ANF] for 2 sec., one or more times, to select the filter width.
 - W=320 Hz, M=160 Hz, N=80 Hz.
- ③ Rotate the [APF] control to adjust the center frequency of the peak frequency.

ABOUT THE CW PITCH CONTROL

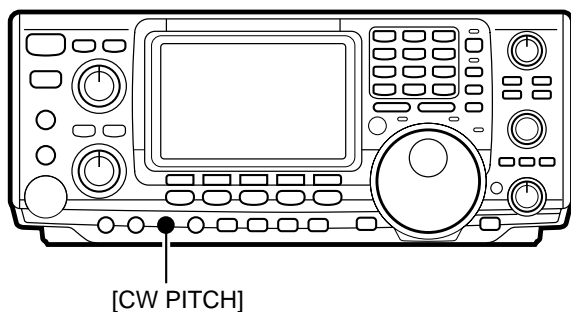

The received CW audio pitch and monitored CW audio can be adjusted to suit your preferences (300 to 900 Hz in 3 Hz steps) without changing the operating frequency.

➔ Rotate [CW PITCH] clockwise to increase the pitch frequency; counterclockwise to decrease the pitch frequency.

👉 **NOTE:** When adjusting the CW pitch and the audio peak frequency is ON (see above), the center frequency of the audio peak filter may have to be readjusted. Otherwise, receive audio may not be emitted.

✓Convenient functions for receive

① Preamplifier and attenuator (p. 38)

The **preamp** amplifies received signals in the front end circuit to improve the S/N ration and sensitivity. The **attenuator** prevents a desired signal from distorting when very strong signals are near the desired frequency or when very strong electric fields, such as from a broadcasting station, are near you.

② Noise blanker (p. 39)

The noise blanker is used to reduce pulse-type noise caused by vehicle ignition systems and key clicks from strong CW signals on nearby frequencies.

③ Noise reduction (p. 40)

The noise reduction function reduces noise components and picks out desired signals which are buried in noise. This function digitally transposes receive audio components to produce desired AF frequency characteristics at the IF stage.

④ Twin PBT (passband tuning) (p. 41)

The PBT function electronically narrows the receiver's IF passband widths to reduce interference. Moving both [TWIN PBT] controls to the same position shifts the IF.

⑤ AGC (auto gain control) (p. 39)

The AGC controls receiver gain to produce a constant audio output level even when the received signal strength is varied by fading, etc.

⑥ 1/4 function (p. 39)

Normally, one rotation of the tuning dial changes the frequency by about 5 kHz (in 10 Hz tuning steps). Using the 1/4 function sets the tuning dial so that one rotation changes the frequency by about 1.25 kHz (in 10 Hz steps). This is convenient for critical tuning.

4 USING DIFFERENT OPERATING MODES

■ TRANSMITTING

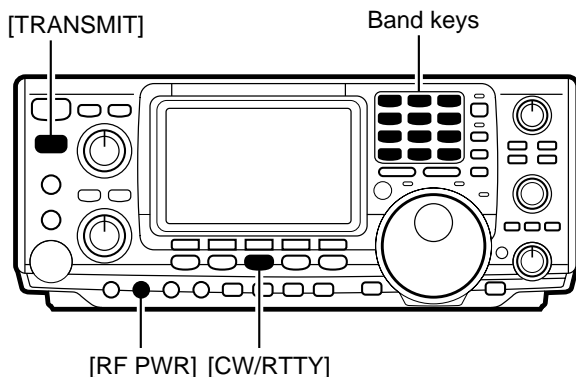

Before transmitting, monitor your selected operating frequency to make sure transmitting won't cause interference to other stations on the same frequency.

- ① Connect an electronic keyer or paddle to the [ELEC-KEY] jack on the rear panel of the transceiver (p. 68).
- ② Push a band key to select the desired band.
- ③ Push [CW/RTTY] to select CW or CW-R.
 - Push [CW/RTTY] for 2 sec. to toggle between CW and CW-R modes.
- ④ Rotate [AF] to set audio to a comfortable listening level.
- ⑤ Push [TRANSMIT] to set the transceiver to the transmit condition.
- ⑥ Use the electronic keyer or paddle to key your CW signals.
 - The P₀ meter indicates transmitted CW signal strength.

■ ABOUT KEYING SPEED

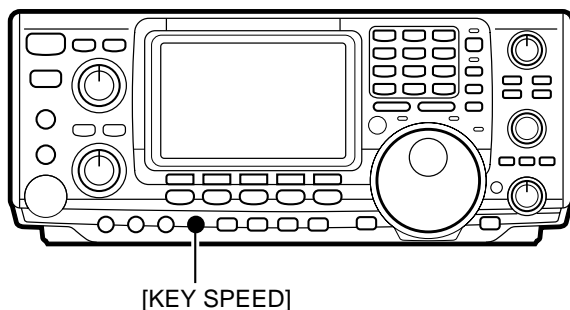

The transceiver's internal electronic keyer speed can be adjusted from 6 to 60 wpm.

- ➔ Rotate [KEY SPEED] clockwise to increase keying speed; counterclockwise to decrease keying speed.

■ CW SIDE TONE FUNCTION

When the transceiver is in the receive condition (and the break-in function is OFF—p. 44) you can listen to the tone of your CW signal without actually transmitting. This allows you to match your transmit signal exactly to another station's. This also convenient for CW practice. CW side tone level can be adjusted in CW set mode (p. 27).

✓ Convenient functions for transmit

Break-in function (p. 44)

The break-in function automatically toggles the transceiver between transmit and receive when operating CW. This function can be set to full break-in or semi break-in.

E ELECTRONIC KEYSER FUNCTIONS

(1) Memory keyer settings menu

The transceiver has a number of convenient functions for the electronic keyer that can be accessed from the memory keyer menu.

- ① Push [CW/RTTY] to select CW mode.
- ② Push [MENU] to select M1.
- ③ Push [F4] to select the memory keyer menu.
- ④ Push one of the multi-function keys ([F1] to [F5]) to select an item in the memory keyer menu. See the diagram below.

IN CW MODE

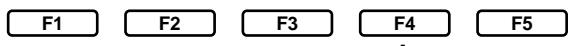
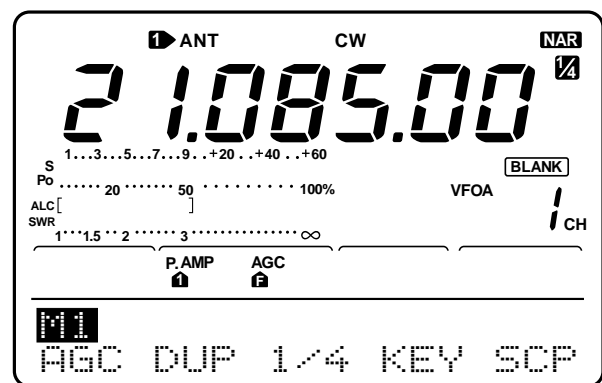

Memory keyer menu

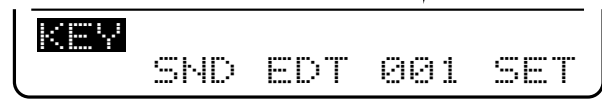

Transmit (SND) menu

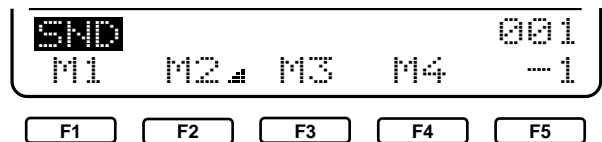

Edit (EDT) menu

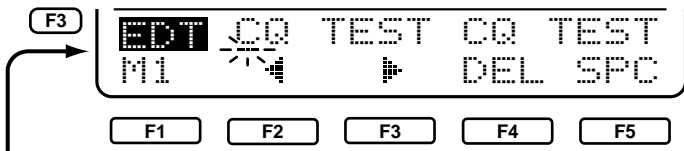

Contest number (001) menu

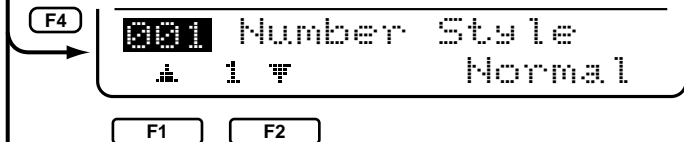

Keyer set (SET) menu

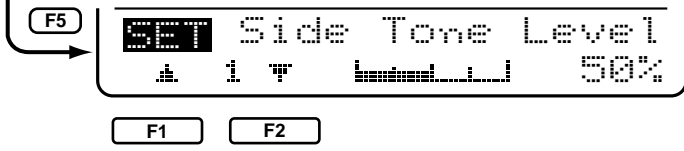

4 USING DIFFERENT OPERATING MODES

(2) Memory keyer send menu

■ TRANSMITTING

Send menu

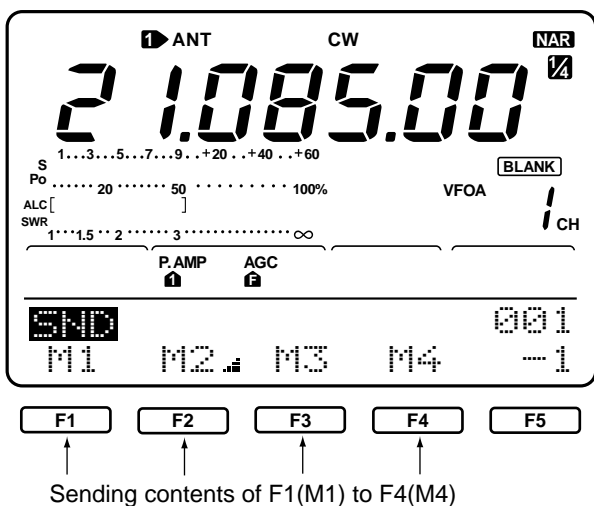

M1 send indication

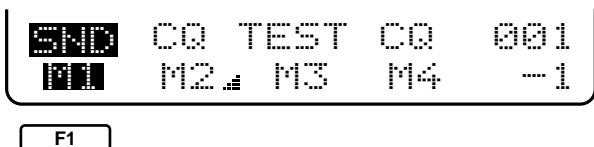

Repeat send indication



M2 send indication

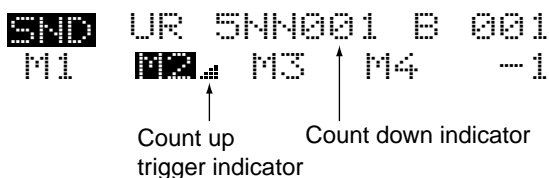

Pre-set characters can be sent using the memory keyer send menu. Contents of the memory keyer are set using the edit menu.

- ① Push [TRANSMIT] to set the transceiver to transmit, or set the break-in function ON (p. 44).
 - When the transceiver is in receive, step ② monitors the memory keyer contents, but does not transmit them.
- ② Push one of the function keys ([F1] to [F4]) to send the contents of the memory keyer.
 - The currently active memory keyer contents is indicated by a triangle beside it.
 - Pushing a function key for 2 sec. repeatedly sends the contents; push any function key to cancel the transmission.
 - The contest number counter, above [F5], is incremented each time the contents are sent.
 - The contest number trigger can be set in the contest number menu.
 - Push [F5] to manually increment the contest number.
- ③ Push [MENU] 2 times to return to M1.

M2 send indication



M3 send indication



M4 send indication

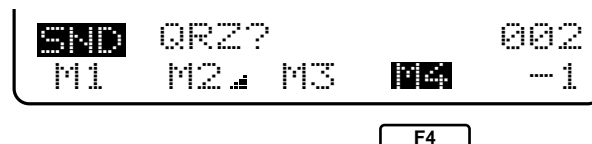

(3) Memory keyer edit menu

PROGRAMMING CONTENTS

Edit (EDT) menu

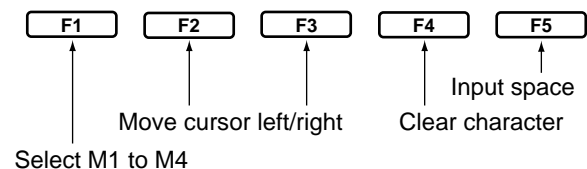
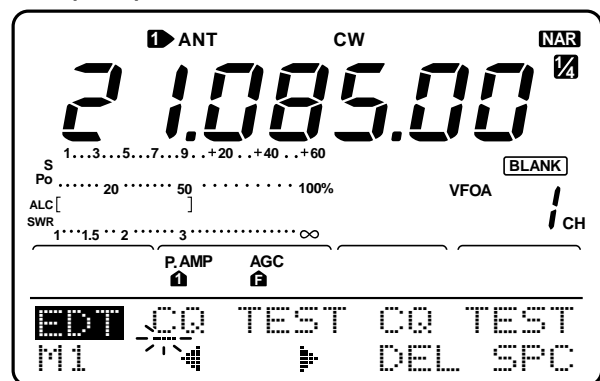

• M2 indication



• M3 indication



• M4 indication

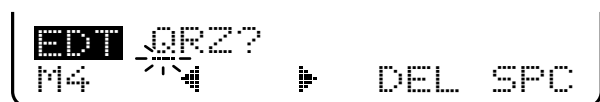

About the contents of M2

UR 5NN* BK

↑
When inputting an asterisk,
the counter is incremented by 1.

The contents of the memory keyer memories can be set using the memory keyer edit menu. The memory keyer can memorize and re-transmit 4 CW key codes for often-used CW sentences, contact numbers, etc. Total capacity of the memory keyer is 50 characters per memory channel.

- ① Push [F1]M1 to select memory for editing.
- ② Input the desired character by rotating the tuning dial or by pushing the keypad for number input.
 - All uppercase letters of the alphabet can be selected as well as “/” “?” “^” “.” “,” and “*”.
- ③ Push [F2] or [F3] to move the cursor backwards or forwards, respectively.
- ④ Repeat steps ② and ③ to input the desired characters.
- ⑤ Push [MENU] 2 times to return to regular operation.

☞ **NOTE:** “^” is used to transmit a following word with no space such as \overline{AR} . Put “^” before a text string such as $\overline{^AR}$, and the string “ \overline{AR} ” is sent with no space.

☞ **NOTE:** “*” is used to insert the CW contact number. The contact number automatically increments by 1. This function is only available for one memory keyer channel at a time. Memory keyer channel M2 uses “*” by default.

Pre-programmed contents

MCH	CONTENTS
M1	CQ TEST CW TEST DE JA1 JA1 TEST
M2	UR 5NN* BK
M3	CFM TU
M4	QRZ?

• Example display when inputting



4 USING DIFFERENT OPERATING MODES

(4) Contact number menu

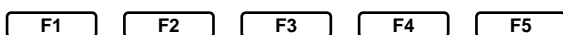
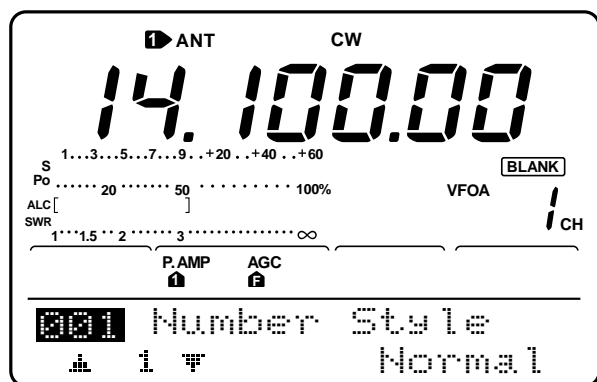

Set item up/down

This menu is used to set the contact (serial) number and count up trigger, etc.

- ① Push [F1] or [F2] to select the set contents.
- ② Rotate the tuning dial to set the condition.
 - See below for details.
- ③ Push [MENU] 2 times to return to regular operation (M1).

SET MODE ITEM AND DEFAULT CONDITION	DESCRIPTION
	<p>This item sets the numbering system used for contact (serial) numbers—normal or morse cut numbers.</p> <ul style="list-style-type: none"> • Normal: does not use morse cut numbers (default). • 190→ANO: sets 1 as A, 9 as N and Ø as O. • 190→ANT: sets 1 as A, 9 as N and Ø as T. • 90→NO: sets 9 as N and Ø as O. • 90→NT: sets 9 as N and Ø as T.
	<p>This item sets the count up trigger channel.</p> <ul style="list-style-type: none"> • M1, M2, M3 or M4 can be set.
	<p>This item shows the current number for the count up trigger channel set above.</p> <ul style="list-style-type: none"> • Rotate the tuning dial to change the number, or push [F3](CLR) for 2 sec. to reset the current number to 001.

(5) CW keyer set menu

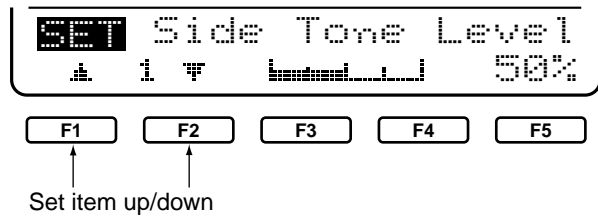

This menu is used to set the CW side tone, memory keyer repeat time, dash weight, paddle specifications, keyer type, etc.

- ① Push [F1] or [F2] to select the set contents.
- ② Rotate the tuning dial to set the condition.
 - See below for details.
- ③ Push [MENU] 2 times to return to regular operation (M1).

SET MODE ITEM AND DEFAULT CONDITION	DESCRIPTION
	This item sets the CW side tone. • 0 to 100% in 1% steps can be selected.
	This item sets the CW side tone level limit. When the [AF] control is rotated above a specified level, the CW side tone does not increase. • OFF: CW side tone level is not limited. • ON: CW side tone level is limited.
	When sending CW using the repeat timer, this item sets the time between transmissions. • 1, 2, 10 or 30 sec. can be selected.
	This item sets the dash/dot ratio. • 1:1:2.8 to 1:1:4.5 (in 0.12 steps) can be selected.
	This item sets the paddle polarity. • Normal and reverse polarity can be selected.
	This item sets the keyer type. • ELEC-KEY, BUG KEY and Straight can be selected.
	This item allows you to set the microphone [UP]/[DN] switches to be used as a paddle. • ON: [UP]/[DN] switches can be used for CW. • OFF: [UP]/[DN] switches cannot be used for CW. ☞ NOTE: When “ON” is selected, the frequency and memory channel cannot be changed using the [UP]/[DN] switches.

4 USING DIFFERENT OPERATING MODES

4-3 Operating RTTY (FSK)

■ RECEIVING

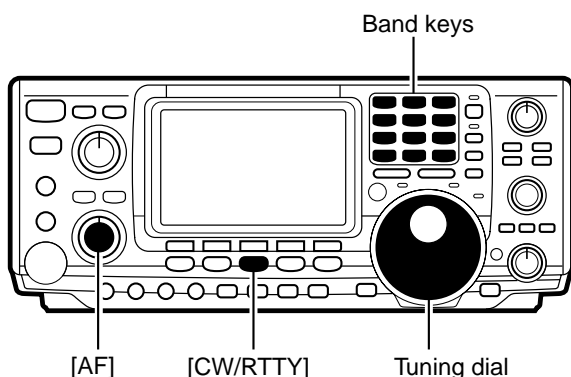

Before operating RTTY be sure to consult the manual that came with your TNC.

- ① Connect RTTY capable TNC and personal computer or an RTTY terminal (p. 68)
- ② Push a band key to select the desired band.
- ③ Push [CW/RTTY] to select RTTY.
- ④ Rotate [AF] to set audio to a comfortable listening level.
- ⑤ Rotate the tuning dial to set the desired frequency.
 - S-meter indicates received signal strength.
 - If the received signal cannot be demodulated, try selecting RTTY-R mode.

■ ABOUT RTTY REVERSE MODE

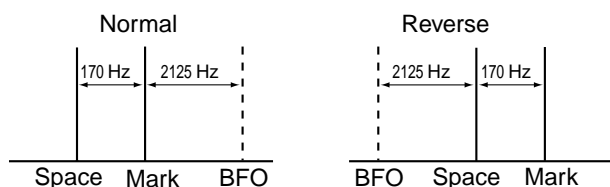

Received characters are occasionally garbled when the receive signal is reversed between MARK and SPACE. This reversal can be caused by incorrect TNC connections, setting, commands, etc. To receive a reversed RTTY signal correctly, select RTTY-R mode.

✓ Convenient functions for receive

① Preamp and attenuator (p. 38)

The **preamp** amplifies received signals in the front end circuit to improve the S/N ration and sensitivity. The **attenuator** prevents a desired signal from distorting when very strong signals are near the desired frequency or when very strong electric fields, such as from a broadcasting station, are near you.

② Noise blanker (p. 39)

The noise blanker is used to reduce pulse-type noise caused by vehicle ignition systems and key clicks from strong CW signals on nearby frequencies.

③ Noise reduction (p. 40)



The noise reduction function reduces noise components and picks out desired signals which are buried in noise. This function digitally transposes receive audio components to produce desired AF frequency characteristics at the IF stage.

④ Twin PBT (passband tuning) (p. 41)

The PBT function electronically narrows the receiver's IF passband widths to reduce interference. Moving both [TWIN PBT] controls to the same position shifts the IF.

⑤ AGC (auto gain control) (p. 39)

The AGC controls receiver gain to produce a constant audio output level even when the received signal strength is varied by fading, etc.

⑥ 1/4 function (p. 39)

Normally, one rotation of the tuning dial changes the frequency by about 5 kHz (in 10 Hz tuning steps). Using the 1/4 function sets the tuning dial so that one rotation changes the frequency by about 1.25 kHz (in 10 Hz steps). This is convenient for critical tuning.

B TRANSMITTING

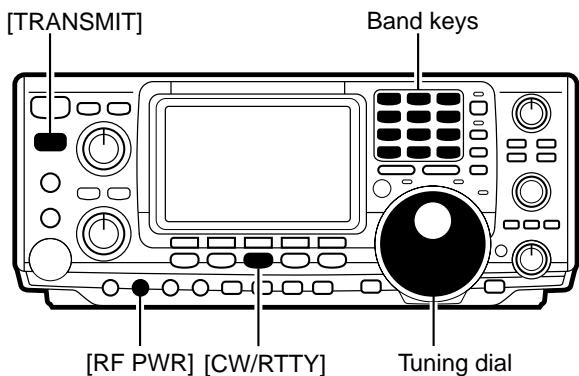

Before transmitting, monitor your selected operating frequency to make sure transmitting won't cause interference to other stations on the same frequency.

- ① Connect RTTY capable TNC and personal computer or an RTTY terminal (p. 68)
- ② Push a band key to select the desired band.
- ③ Push [CW/RTTY] to select RTTY or RTTY-R.
 - Push [CW/RTTY] for 2 sec. to toggle between RTTY and RTTY-R modes.
- ④ Rotate [AF] to set audio to a comfortable listening level.
- ⑤ Push [TRANSMIT] to set the transceiver to the transmit condition or transmit a SEND signal from your TNC.
 - The P₀ meter indicates transmitted RTTY signal strength.
- ⑥ Operate the connected PC or TNC (TU) to transmit RTTY (FSK) signals.

C SETTINGS FOR RTTY

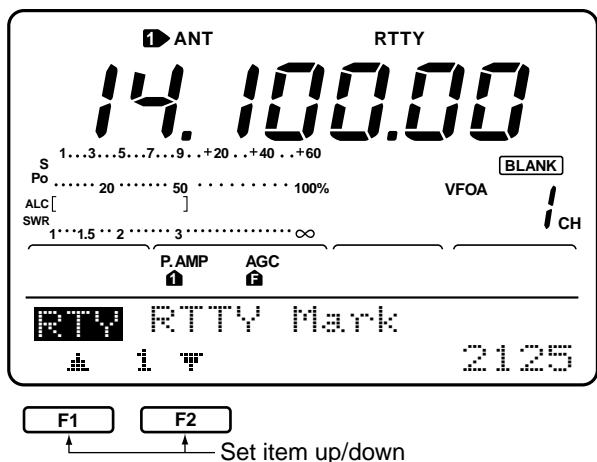

Mark and shift frequencies as well as RTTY keying can be set for RTTY operation.

- ① Push [F4] (RTTY) to select the RTTY menu.
- ② Push [F1] or [F2] to select the desired item.
- ③ Rotate the tuning dial to select the desired condition.
 - See the table below.
- ④ Push [MENU] 2 times to return to normal operation.

SET MODE ITEM AND DEFAULT CONDITION	DESCRIPTION
	Sets the mark frequency for RTTY operation. • 1275, 1615 and 2125 Hz are selectable.
	Sets the shift frequency for RTTY operation. • 170, 200 and 425 Hz are selectable.
	Sets the keying polarity for RTTY operation. • NORMAL: key open=mark key closed=space • REVERSE: key open=space key closed=mark

4-4 Operating AM

A RECEIVING

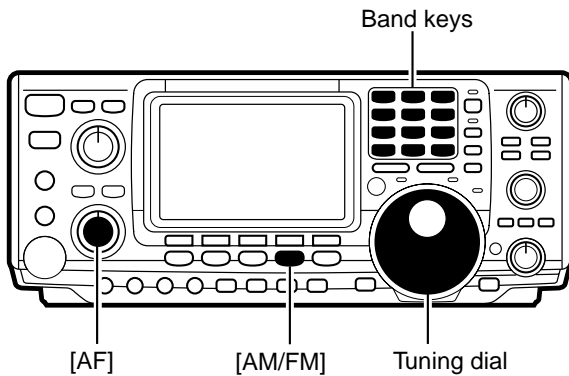

- ① Push a band key to select the desired band.
- ③ Push [AM/FM] to select AM.
 - Pushing [AM/FM] toggles between AM and FM operation.
- ③ Rotate [AF] to set audio to a comfortable listening level.
- ④ Rotate the tuning dial to set the desired frequency.
 - S-meter indicates received signal strength.
 - The default tuning step for AM mode is 1 kHz; this can be changed using tuning step program mode (p. 16).

✓ Convenient functions for receive

① **Preamplifier and attenuator** (p. 38)

The **preamp** amplifies received signals in the front end circuit to improve the S/N ration and sensitivity. The **attenuator** prevents a desired signal from distorting when very strong signals are near the desired frequency or when very strong electric fields, such as from a broadcasting station, are near you.

② **Noise blanker** (p. 39)

The noise blanker is used to reduce wide pulse-type caused by vehicle ignitions and key clicks from strong CW signals on nearby frequencies. In some cases, using the noise blanker may cause receive audio distortion. Turn the noise blanker off in such cases.

③ **Noise reduction** (p. 40)



The noise reduction function reduces noise components and picks out desired signals which are buried in noise. The received AF signals are converted to digital signals and then the desired signals are separated from the noise.

④ **Auto notch filter** (p. 40)



The auto notch function automatically attenuates more than 3 beat tones, tuning signals, etc., even if they are moving.

④ **Twin PBT (passband tuning)** (p. 41)

The PBT function electronically narrows the receiver's IF passband widths to reduce interference. Moving both [TWIN PBT] controls to the same position shifts the IF.

⑤ **AGC (auto gain control)** (p. 39)

The AGC controls receiver gain to produce a constant audio output level even when the received signal strength is varied by fading, etc.

B TRANSMITTING

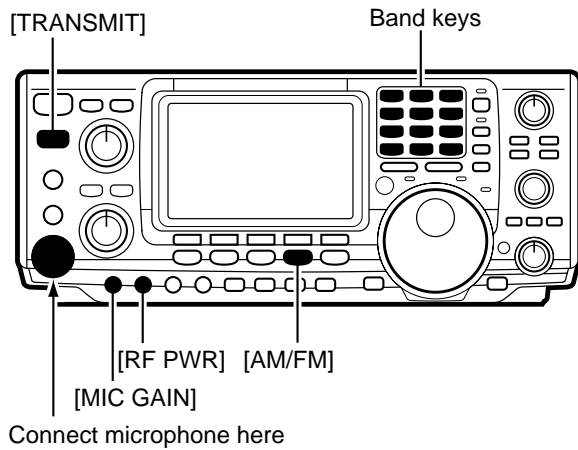

Before transmitting, monitor your selected operating frequency to make sure transmitting won't cause interference to other stations on the same frequency.

- ① Connect a microphone to the [MIC] connector.
- ② Push a band key to select the desired band.
- ③ Push [AM/FM] to select AM.
 - Pushing [AM/FM] toggles between AM and FM.
- ④ Rotate [AF] to set audio to a comfortable listening level.
- ⑤ Push [TRANSMIT] or push and hold [PTT] to transmit, then speak into the microphone to transmit.
 - The P₀ meter indicates transmitted AM signal strength.
- ⑥ Push [TRANSMIT] or release [PTT] to return to receive.

✓ Convenient functions for transmit

① Speech compressor (p. 46)

The speech compressor compresses the transmitter audio input to increase the average audio output level. Therefore, talk power is increased. This function is effective for long distance communication or when propagation conditions are poor.

② VOX (voice activated transmit) (p. 43)

The VOX function starts transmission without pushing the transmit switch or PTT switch when you speak into the microphone; then, automatically returns to receive when you stop speaking.

③ Transmit quality monitor (p. 45)

This function allows you to monitor the quality of your transmitted signal.

4 USING DIFFERENT OPERATING MODES

4-5 Operating FM

RECEIVING

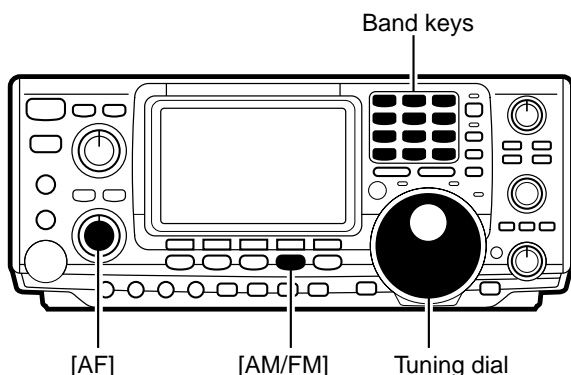

TONE SQUELCH OPERATION

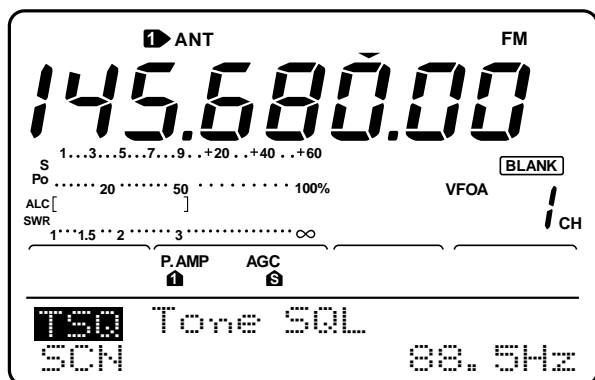

TONE SCAN

Display during tone scan

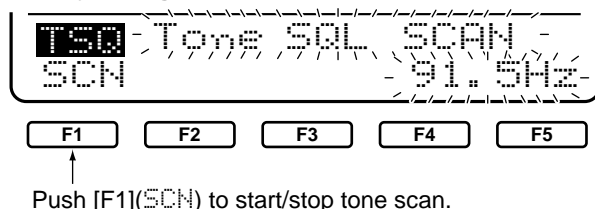

- ① Push a band key to select the desired band.
- ③ Push [AM/FM] to select FM.
 - Pushing [AM/FM] toggles between AM and FM operation.
- ③ Rotate [AF] to set audio to a comfortable listening level.
- ④ Rotate [SQL] to the point where audio noise is just muted.
- ⑤ Rotate the tuning dial to set the desired frequency.
 - S-meter indicates received signal strength.
 - The default tuning step for FM mode is 10 kHz; this can be changed using tuning step program mode (p. 16).

Tone squelch operation is a method of communications using selective calling. Only received signals having a matching tone will open the squelch. Before communicating using tone squelch, all members of your party must agree on the tone squelch frequency to use.

- ① While in FM mode, push [MENU] to select menu set 1.
- ② Push [F4](TSQL) for 2 sec. to select the tone squelch frequency set menu.
- ③ Rotate the tuning dial to select the desired tone squelch frequency.
- ④ Push [F4](TSQL) momentarily to turn the tone squelch function ON or OFF.
 - "TSQL" appears in the display when the function is ON.
- ⑤ Communicate in the usual manner.

Available tone squelch frequencies (unit: Hz)

67.0	79.7	94.8	110.9	131.8	156.7	171.3	186.2	203.5	229.1
69.3	82.5	97.4	114.8	136.5	159.8	173.8	189.9	206.5	233.6
71.9	85.4	100.0	118.8	141.3	162.2	177.3	192.8	210.7	241.8
74.4	88.5	103.5	123.0	146.2	165.5	179.9	196.6	218.1	250.3
77.0	91.5	107.2	127.3	151.4	167.9	183.5	199.5	225.7	254.1

By monitoring a signal that is being transmitted on a repeater input frequency, you can determine the tone frequency necessary to open a repeater.

- ① Set tone squelch operation as in steps ① to ② above.
- ② Push [F4](SCAN) to toggle the tone scan ON and OFF.
 - "Tone SQL SCAN" appears
- ③ When a matched tone is found, a beep sounds and the tone frequency is programmed into the selected mode.
 - Tone scan pauses when a tone frequency is detected.

✓Convenient functions for receive

❶ Preamplifier and attenuator (p. 38)

The **preamp** amplifies received signals in the front end circuit to improve the S/N ration and sensitivity. The **attenuator** prevents a desired signal from distorting when very strong signals are near the desired frequency or when very strong electric fields, such as from a broadcasting station, are near you.

❷ Noise reduction (p. 39)



The noise reduction function reduces noise components and picks out desired signals which are buried in noise. The received AF signals are converted to digital signals and then the desired signals are separated from the noise.

❸ Auto notch filter (p. 40)



The auto notch function automatically attenuates more than 3 beat tones, tuning signals, etc., even if they are moving.

B TRANSMITTING

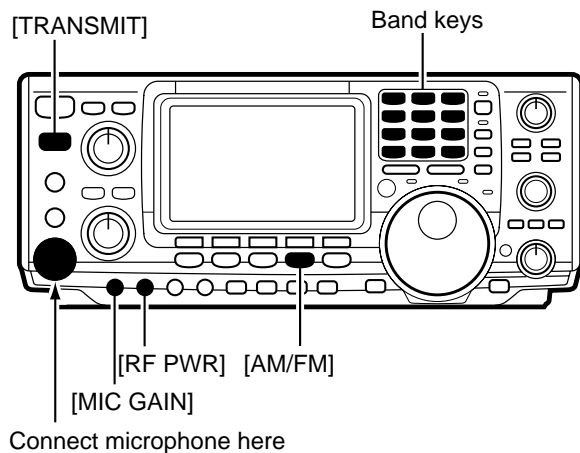

Before transmitting, monitor your selected operating frequency to make sure transmitting won't cause interference to other stations on the same frequency.

- ❶ Connect a microphone to the [MIC] connector.
- ❷ Push a band key to select the desired band.
- ❸ Push [AM/FM] to select FM.
 - Pushing [AM/FM] toggles between AM and FM.
- ❹ Rotate [AF] to set audio to a comfortable listening level.
- ❺ Push [TRANSMIT] or push and hold [PTT] to transmit, then speak into the microphone to transmit.
- ❻ Push [TRANSMIT] or release [PTT] to return to receive.

✓Convenient functions for transmit

❶ VOX (voice activated transmit) (p. 43)

The VOX function starts transmission without pushing the transmit switch or PTT switch when you speak into the microphone; then, automatically returns to receive when you stop speaking.

❷ Transmit quality monitor (p. 45)

This function allows you to monitor the quality of your transmitted signal.

4-6 Repeater operation

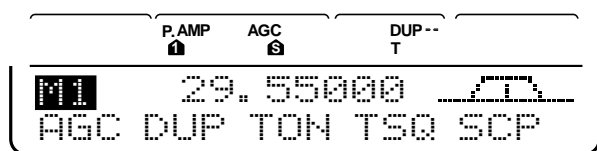
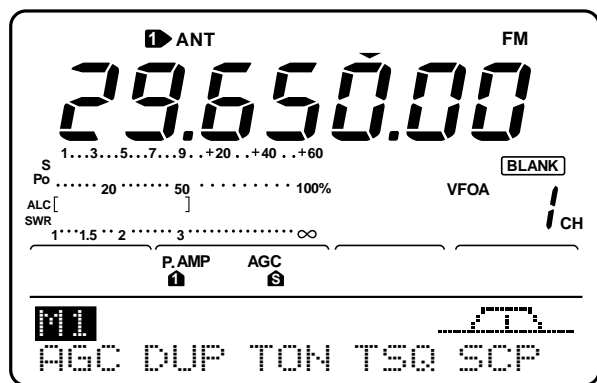

■ ONE-TOUCH REPEATER FUNCTION

NOTE: Set the offset shift direction and frequency in advance (pgs. 60, 61) as well as the repeater tone frequency (see below).

■ TRANSMIT FREQUENCY MONITOR CHECK

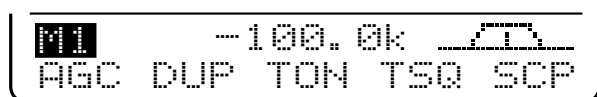

■ REPEATER TONE FREQUENCIES

67.0	82.5	100.0	123.0	151.4	171.3	189.9	210.7	250.3
69.3	85.4	103.5	127.3	156.7	173.8	192.8	218.1	254.1
71.9	88.5	107.2	131.8	159.8	177.3	196.6	225.7	1750
74.4	91.5	110.9	136.5	162.2	179.9	199.5	229.1	
77.0	94.8	114.8	141.3	165.5	183.5	203.5	233.6	
79.7	97.4	118.8	146.2	167.9	186.2	206.5	241.8	

A repeater amplifies received signals and retransmits them at a different frequency. When using a repeater, the transmit frequency is shifted from the receive frequency by an offset frequency. A repeater can be accessed using split frequency operation with the shift frequency set to the repeater's offset frequency.

- ① Push [A/B] to select VFO A.
- ② Push a band key to select the desired band.
- ③ Push [AM/FM] to select FM mode.
 - Pushing [AM/FM] toggles between AM and FM modes.
- ④ Rotate the tuning dial to set the repeater transmit frequency.
- ⑤ While menu set 1 is selected, push [F2](DUP) one or more times to set the offset direction.
 - The offset frequency is set in advance in set mode.
- ⑥ While menu set 1 is selected, push [F3](TON) to turn the repeater tone function ON or OFF.

When 1750 Hz European repeater tone is selected in set mode as below, push [F3](TON) while transmitting to transmit 1750 Hz tone.

- ⑦ Communicate in the normal way.

This function allows you to set repeater operation with the push of one switch.

- ➔ To set the transceiver for repeater operation using the one-touch repeater function, follow the steps above but instead of steps ⑤ and ⑥ push [AM/FM] for 2 sec.

You may be able to receive the other party's transmit signal directly without having to go through a repeater. This function allows you to check this.

- ➔ While receiving, push [XFC] to see if you can receive the other party's transmit signal directly.

The transceiver's repeater tone frequency is set to 88.5 Hz by default. This can be changed if desired.

- ① While menu set 1 is selected, push [F3](TON) for 1 sec. to select the repeater tone frequency menu.
- ② Rotate the tuning dial to select the desired frequency (see table at left.)
 - A 1750 Hz tone is available for operating European repeaters.
- ③ Push [MENU] to return to menu set 1.

• Repeater tone frequency menu

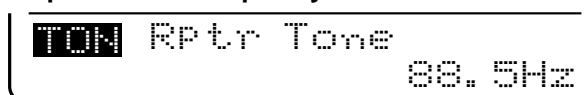

■ AUTO REPEATER FUNCTION

☞ **NOTE:** This function is available for the USA version only.

This function automatically activates the repeater settings (DUP or DUP– and tone encoder ON/OFF) when the operating frequency falls within the general repeater output frequency range and deactivates them when outside of the range.

Set the auto repeater function ON-1 or ON-2 in set mode in advance. (p. 62) When set ON, repeater settings are automatically activated according to the table below.

ON-1 automatically sets the duplex setting and ON-2 automatically sets the duplex setting and tone encoder automatically.

Frequency range and offset direction

FREQUENCY RANGE	DUPLEX DIRECTION
145.200–145.495 MHz	minus duplex
146.610–146.995 MHz	minus duplex
147.000–147.395 MHz	plus duplex

■ STORING A NON STANDARD REPEATER

- ① For the USA version, turn the auto repeater function OFF in set mode. (p. 62)
- ② Turn the quick split function ON in set mode. (p. 61)
- ③ Push [AM/FM] to select FM mode.
 - Pushing [AM/FM] toggles between AM and FM modes.
- ④ Push [A/B] to select VFO A.
- ⑤ Rotate the tuning dial to set the repeater output frequency.
 - Set the tuning step if desired.
- ⑥ Push [A/B] to select VFO B.
- ⑦ Rotate the tuning dial to set the repeater input frequency.
- ⑧ Push [A/B] to select VFO A.
- ⑨ Push [SPLIT] to turn the split function ON.
- ⑩ Push [F3](TONE) to turn the previously set tone encoder ON.
- ⑪ Push [MW] for 2 sec. to store the contents in the selected memory channel.

4-7 Packet operation

A RECEIVING

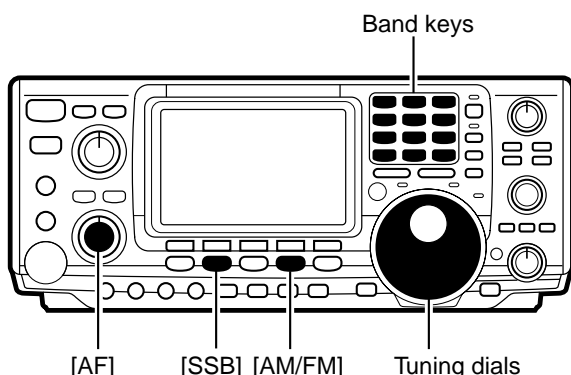

Before operating packet (AFSK) be sure to consult the operating manual that came with your TNC.

- ① Connect a TNC and personal computer (p. 68)
- ② Push a band key to select an operating band.
- ③ Push a mode key to select an operating mode.
 - Generally, LSB is used for packet operation on the HF bands and FM is used for packet operation on the VHF band.
- ④ Rotate [AF] to set the audio to a comfortable listening level.
- ⑤ Rotate the tuning dial to tune the desired signal.
 - Received signal strength is indicated in the S-meter.

B TRANSMITTING

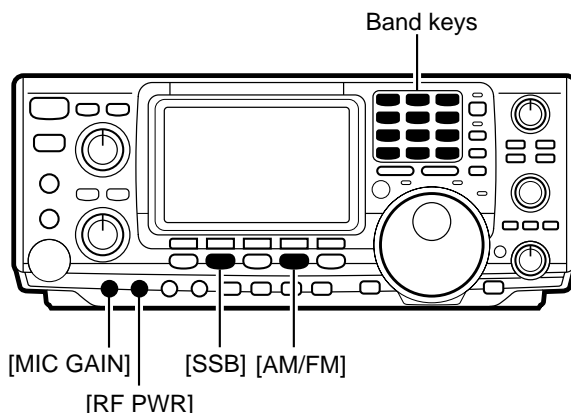

Before transmitting, monitor your selected operating frequency to make sure transmitting won't cause interference to other stations on the same frequency.

- ① Connect a TNC and personal computer (p. 68)
- ② Push a band key to select an operating band.
- ③ Push a mode key to select an operating mode.
 - Generally, LSB is used for packet operation on the HF bands and FM is used for packet operation on the VHF band.
- ④ Rotate [RF PWR] to set the output power.
 - Relative strength of the transmitted signal is indicated in the P₀ meter while operating the TNC.
 - When operating in SSB mode, adjust output power so that the ALC reading in the ALC meter stays in the ALC zone.
- ⑤ Transmit your AFSK signals using your computer's keyboard.

NOTE: When connecting a TNC to the ACC socket on the back of the transceiver, rotate [MIC GAIN] fully counterclockwise and disconnect the microphone from the [MIC] jack.

FREQUENCY INDICATION DURING AFSK

When operating AFSK in SSB mode, the indicated frequency is the signals carrier point.

[EXAMPLE]: HF band, LSB mode, 2125/2325 Hz tone

[EXAMPLE]: VHF band, FM mode, 1200/2200 Hz tone

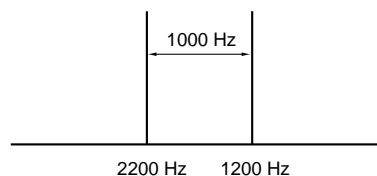
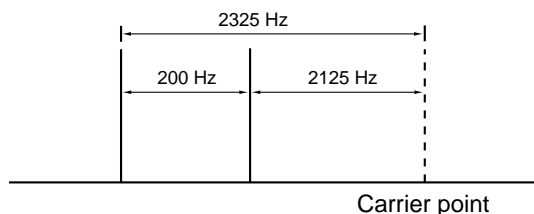

5-1 Simple band scope

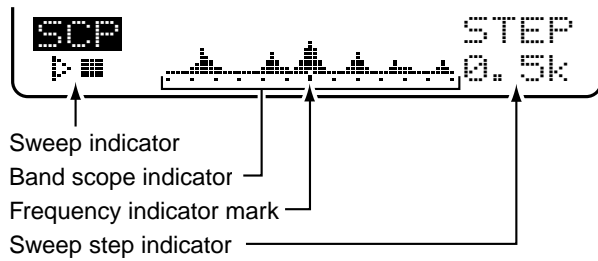

The band scope function allows you to visually check signal condition around a specified frequency. The IC-746's band scope function can be used not only in FM mode but also when operating on HF bands.

INDICATOR	DESCRIPTION
SWEEP	While the band scope is "sweeping," "⏏" appears; while stopped "⏏" appears. Received audio is not emitted from the speaker while the band scope is "sweeping."
BAND SCOPE INDICATOR	Indicates the relative strength of signals and their location in relation to the center frequency. Signal strength is relative to the S-meter level, S1 to S9, with each vertical dot in the band scope indicator equal to one segment of the S-meter. Signal activity is measured ± 30 steps from the center frequency with each step equal to the selected sweep step.
FREQUENCY INDICATOR MARK	After a sweep, indicates the relative position of the selected frequency. When the selected frequency is outside of the sweep range, this indicator flashes. After changing the frequency, push [F3] to automatically return to the center frequency.
SWEEP STEP	Indicates the selected sweep step. 0.5, 1, 2, 5, 10, 20 and 25 kHz are selectable. Each dot of the band scope indication is approx. equal to the selected sweep step.

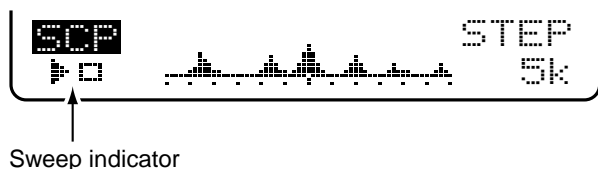
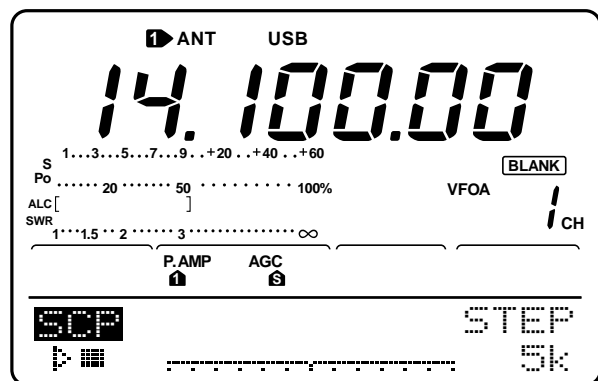

The band scope measures receive signal conditions over a specified range on either side of a selected frequency in either VFO or memory modes.

- ① While menu set 1 is displayed, push [F5](SCP) to select the band scope menu.
- ② Rotate the tuning dial to select a frequency.
- ③ Push [F5](STEP) one or more times to select a sweep step.
 - During sweep operation "⏏" appears and received signals cannot be heard.
 - If there is a lot of signal noise, turn the preamp OFF and the attenuator ON to reduce the signal input level and improve the readability of the band scope.
- ④ When rotating the tuning dial and finding a signal you wish to communicate on, simply communicate normally.
 - If you want to return to the previous frequency (before rotating the tuning dial), push [F3] for 2 sec.
- ⑤ While receiving, if you want to update the band conditions using the selected sweep step, push [F1].
 - Each push of [F1] starts and stops the sweep function.

5-2 Preamp and attenuator

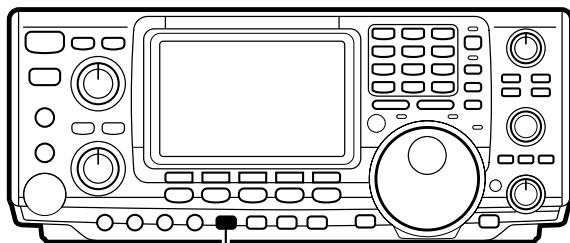

[P.AMP/ATT]

inside dotted line is
1.6–60 MHz operation

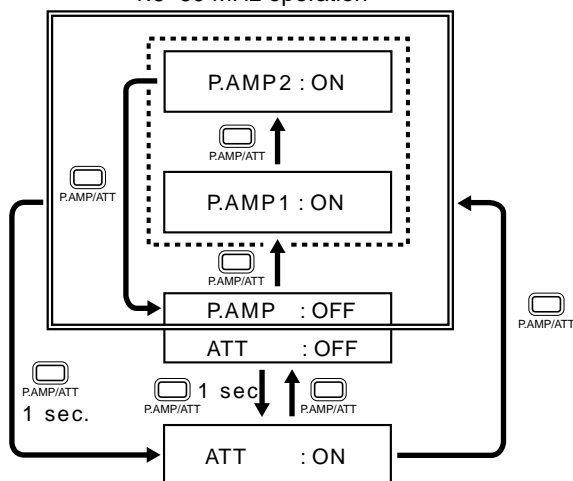

The preamp amplifies received signals in the front end circuit to improve the S/N ratio and sensitivity. Set this to preamp 1 or preamp 2 when receiving weak signals. The attenuator prevents a desired signal from distorting when very strong signals are near the desired frequency or when very strong electric fields, such as from a broadcasting station, are near your location. These can both be set independently for each band.

- ① Push [P.AMP/ATT] momentarily one or more times to set the preamp OFF, set preamp 1 ON or set preamp2 ON.
 - When the preamp is ON, either preamp 1 or preamp2 appears in the function display.
 - When operating on the 144 MHz band, the preamp can only be set to ON or OFF—there is no preamp1 and preamp2.
 - Preamp1 activates the 10 dB preamp for the 1.8 to 54 MHz range; preamp2 activates the 16 dB high-gain preamp for the 21 to 60 MHz range; preamp activates the VHF preamp for the 144 to 146 MHz range (108 to 174 for the USA version).
- ② Push [P.AMP/ATT] for 2 sec. once or twice to set the attenuator ON or OFF.
 - “ATT” appears in the display when the function is set ON.

5-3 RIT function

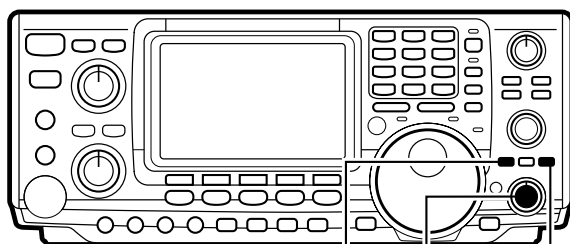

[RIT]

[RIT/TX]

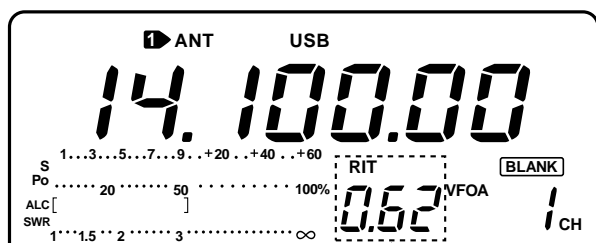

RIT indications

RIT (receiver incremental tuning) shifts the receive frequency up to ± 9.99 kHz in 10 Hz steps without shifting the transmit frequency. This is useful for fine tuning stations which call you on an off-frequency or when you prefer to listen to slightly different sounding voice characteristics, etc.

- ① Push [RIT] to turn the RIT function ON and OFF.
 - RIT and the RIT frequency appear in the function display when the function is ON.
- ② Rotate [RIT/ Δ TX] to set a receive frequency shift.
 - Push [CLEAR] for 2 sec. to set the RIT shift to zero.
 - Push [RIT] for 2 sec. to add the shift frequency to the operating frequency.

■ RIT MONITOR FUNCTION

When the RIT function is ON, pushing and holding [XFC] allows you to monitor the operating frequency directly (RIT is temporarily cancelled).

5-4 AGC function

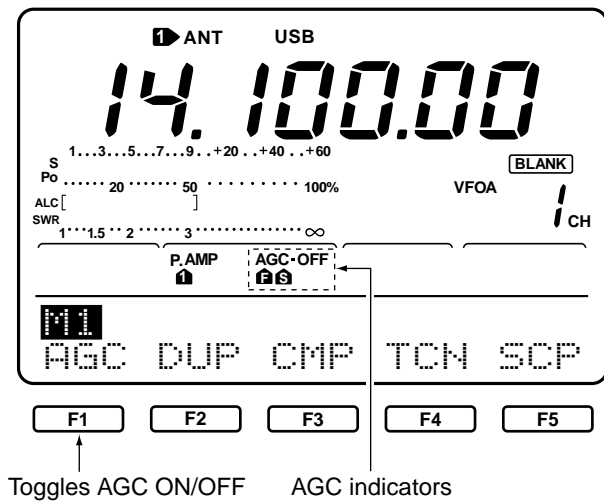

The AGC (auto gain control) controls receiver gain to produce a constant audio output level even when the received signal strength is varied by fading, etc.

- ① While menu set 1 is displayed, push [F1](AGC) one or more times to select AGC fast or AGC slow.
 - The corresponding indicator appears in the display.
 - AGC slow cannot be selected in FM mode.
- ② Push [F1](AGC) for 2 sec. to turn the AGC function OFF.
 - AGC should normally be set to AGC fast for CW and RTTY operation and to AGC slow for SSB and AM operation.
 - Turn AGC OFF when receiving a very weak signal near a strong signal.

☞ **NOTE:** When the AGC function is turned OFF, the S-meter does not function.

5-5 1/4 function

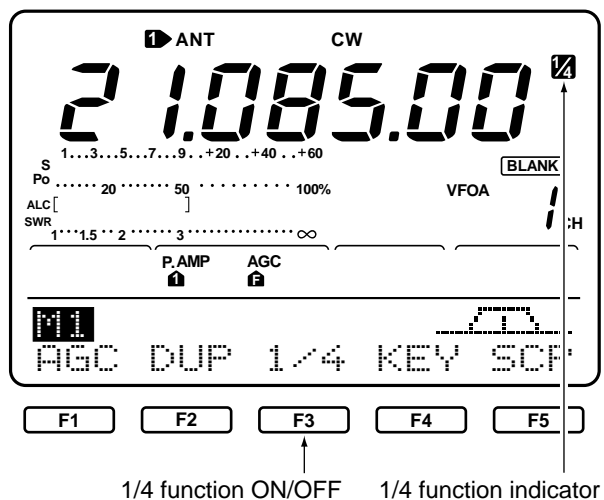

When the 1/4 function is ON, one complete rotation of the tuning dial changes the frequency by 1.25 kHz (normally one rotation changes the frequency by 5 kHz). This is convenient when critical setting is required and is only available in CW and RTTY modes.

- ① Push [CW/RTTY] to select CW or RTTY mode.
- ② While menu set 1 is selected, push [F3](1/4) to toggle the 1/4 function ON and OFF.
 - When the function is ON, "1/4" appears in the function display.
 - This can be set independently for CW and RTTY modes.
 - When the TS function is turned ON, the TS function has priority.

5-6 NB function

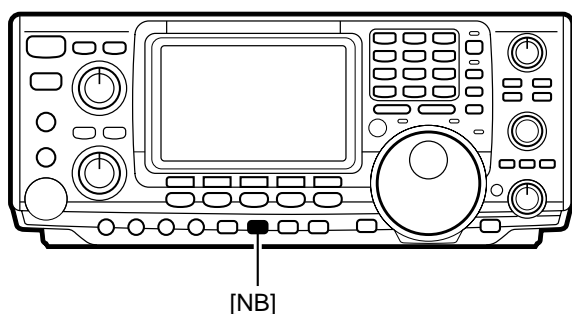

The noise blanker reduces pulse-type noise such as that generated by automobile ignition systems. This function is not effective for AM and FM, or non pulse-type noise.

- ☞ Push [NB] to toggle the noise blanker function ON and OFF.
 - When the noise blanker function is turned ON in AM mode and a strong signal is received, audio may distort. In this case turn the function OFF.

5 FUNCTIONS FOR RECEIVE

5-7 Noise reduction

DSP

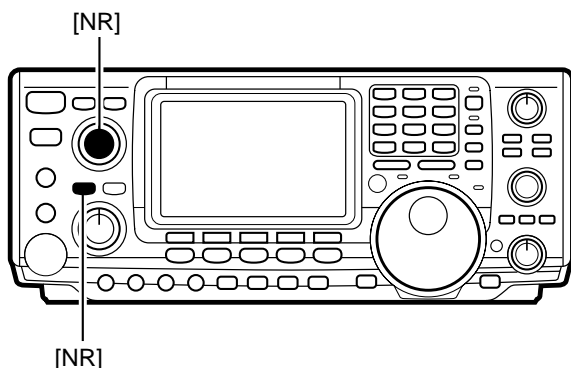

The noise reduction function reduces noise components and picks out desired signals which are buried in noise. The received AF signals are converted to digital signals and then the desired signals are separated from the noise.

- ① Push [NR] to toggle noise reduction ON and OFF.
 - "NR" appears when noise reduction is ON.
- ② Rotate the [NR] control to obtain the desired level of noise reduction.
 - Clockwise rotation increases the level of noise reduction; counterclockwise rotation decreases the level of noise reduction.

5-8 Auto notch (ANF) function

DSP

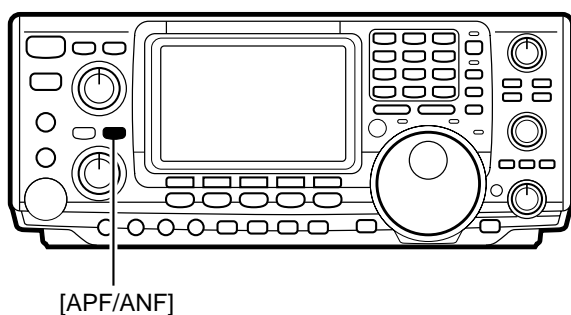

The auto notch function automatically attenuates more than 3 beat tones, tuning signals, etc., even if they are moving. This function is only available in SSB, AM and FM modes.

- ① Push a mode key to select SSB, AM or FM mode.
- ② Push [APF/ANF] to toggle the auto notch filter ON and OFF.
 - "ANF" appears when the function is ON.

5-9 Dial lock function

Lights when the dial lock function is ON

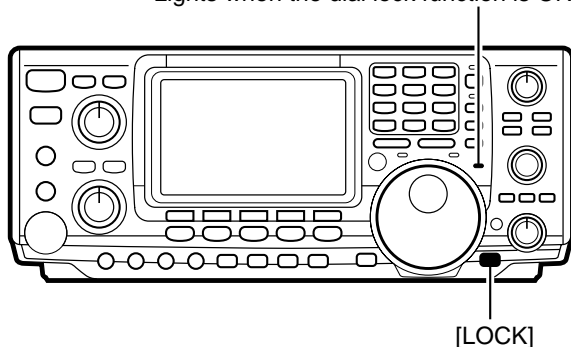

The dial lock function prevents accidental frequency changes caused by inadvertently rotating the tuning dial. This function electronically locks the tuning dial.

- ➔ Push [LOCK] to toggle the dial lock function ON and OFF.
- When the dial lock function is turned ON, the [LOCK] indicator lights red.

5-10 Twin PBT

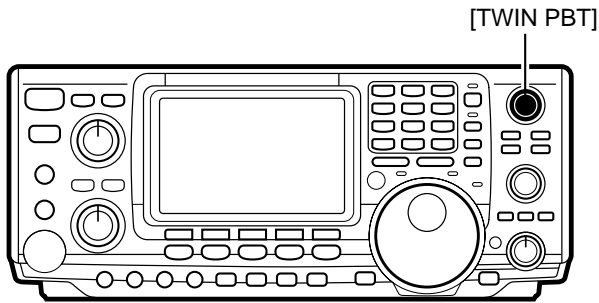

The PBT function electronically narrows the receiver's IF passband widths to reduce interference. Moving both [TWIN PBT] controls to the same position shifts the IF.

- ➔ Rotate the [TWIN PBT] controls to adjust this function. See the illustration below.
- [TWIN PBT] should normally be set to the center positions when there is no interference.
- When PBT is used, the audio tone may change.
- PBT may not function with some IF filter combinations.
- Not available in FM mode.

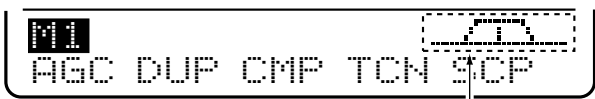

Twin PBT graphic indication

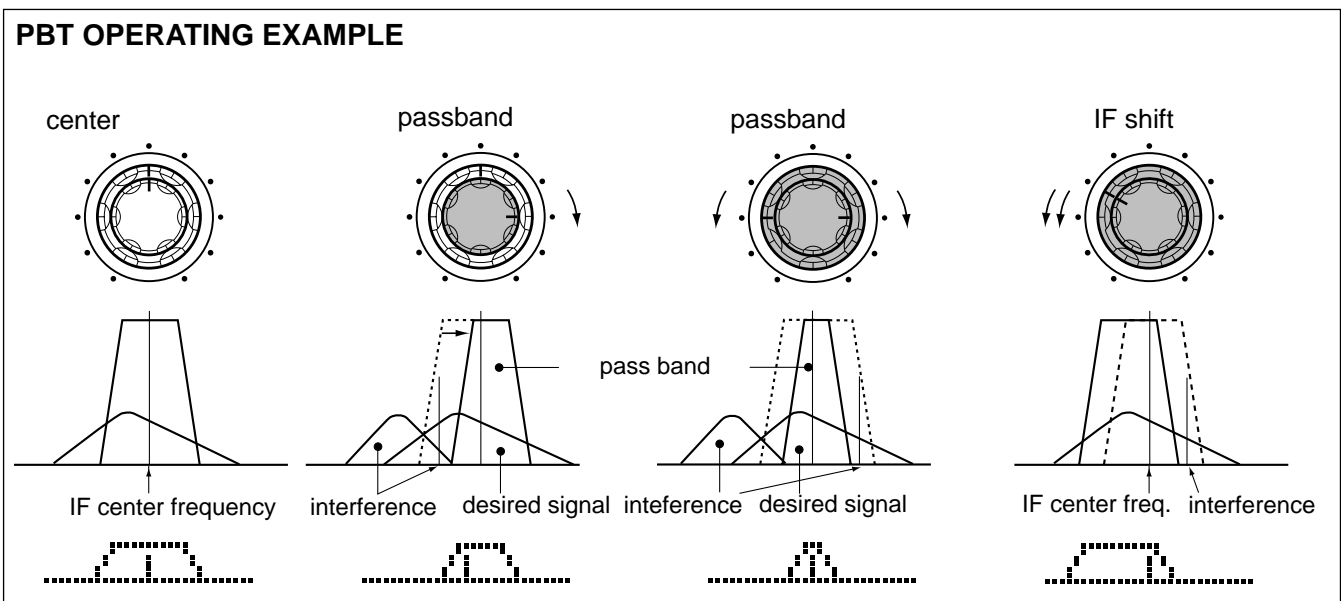

5-11 Selecting IF filters

Optional filters can be installed in the IF stage of the IC-746 (p. 78). Both 9 MHz and 455 kHz IF filters are available. When an optional filter is installed, set the optional filter setting using filter program mode (see below). Filters can be independently selected for each operating mode.

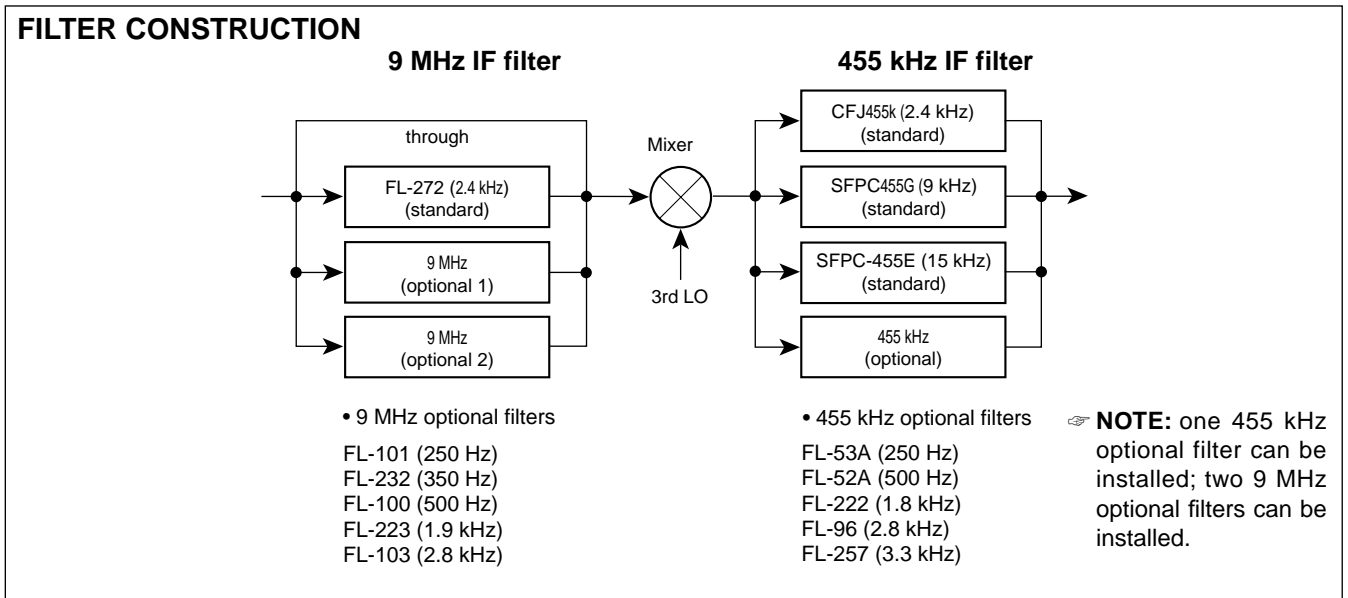

■ FILTER PROGRAM MODE SETTINGS

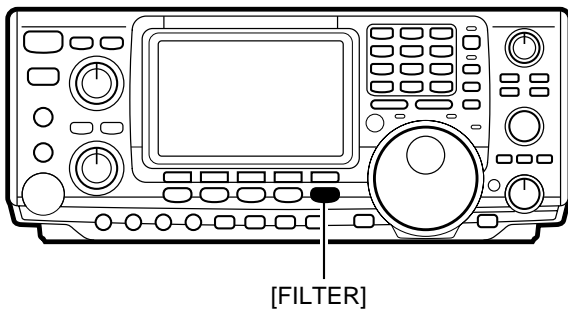

- ① Push [FILTER] for 2 sec. to select filter program mode.
- ② Push a mode key to select an operating mode for the filter setting.
- ③ Push [FILTER] to set the filter condition to normal or narrow.
 - "NAR" appears when narrow is selected.
- ④ Push [F2](9M) or [F4](455k) one or more times to select a 9 MHz filter or a 455 kHz filter, respectively.
- ⑤ Repeat steps ② to ④ to set filters for other operating modes, if desired.
- ⑥ Push [MENU] to return to regular operation.

NOTE: See p. 78 for activating the installed optional filter(s).

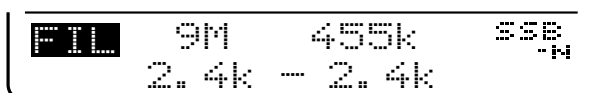
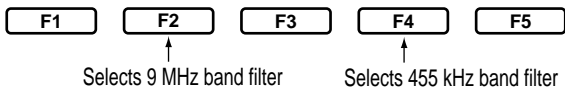

6-1 VOX function

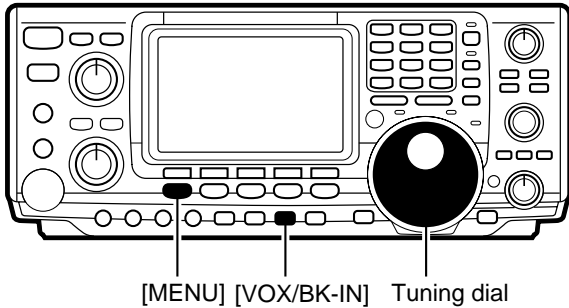

The VOX function starts transmission without pushing the transmit switch or PTT switch when you speak into the microphone; then, automatically returns to receive when you stop speaking. This function is available for SSB, AM and FM modes. Before using this function, follow the steps below.

- ① Select a phone mode (SSB, AM, FM).
- ② Push [VOX/BK-IN] to turn the VOX function ON and OFF.
 - “VOX” appears when the function is ON.
- ③ Push [VOX/BK-IN] for 2 sec. to select VOX program mode.

■ ADJUSTING THE VOX GAIN

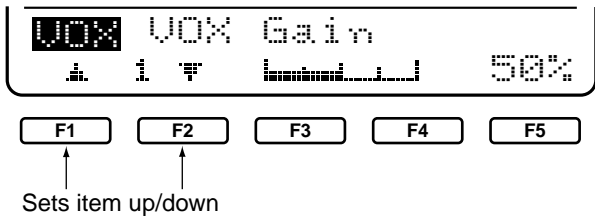

- ① Push [F1] or [F2] to select VOX Gain.
- ② While speaking into the microphone, rotate the tuning dial to the point where the transceiver is continuously transmitting.
 - Be careful that sounds other than your voice are not affecting this setting.
- ③ Push [MENU] or [VOX/BK-IN] to return to menu set 1.

■ ADJUSTING THE ANTI-VOX

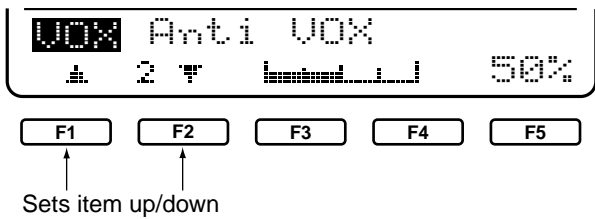

- ① Push [F1] or [F2] to select Anti VOX.
- ② While speaking into the microphone, rotate the tuning dial to obtain the most readable signal.
- ③ Push [MENU] or [VOX/BK-IN] to return to menu set 1.

■ ADJUSTING THE VOX DELAY

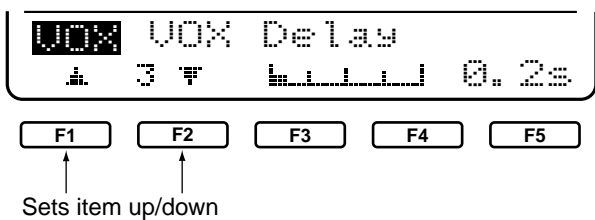

- ① Push [F1] or [F2] to select VOX Delay.
- ② Rotate the tuning dial (and speak into the microphone) to obtain a suitable interval for returning to receive after transmitting.
- ③ Push [MENU] or [VOX/BK-IN] to return to menu set 1.

6 FUNCTIONS FOR TRANSMIT

6-2 Break-in function

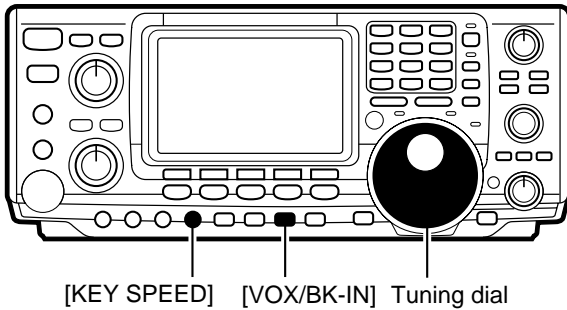

The break-in function is used in CW mode to automatically toggle the transceiver between transmit and receive when keying. The IC-746 is capable for full break-in or semi break-in.

A SEMI BREAK-IN OPERATION

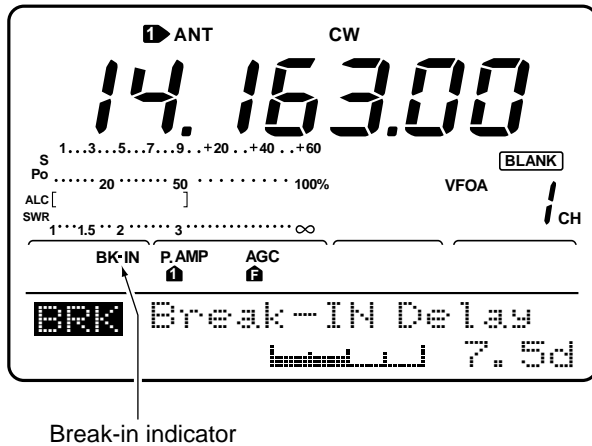

During semi break-in operation, the transceiver selects transceive when keying, then automatically returns to receive after a pre-set time from when you stop keying.

- ① Push [CW/RTTY] to select CW or CW-R mode.
- ② Push [VOX/BK-IN] one or more times to select semi break-in operation.
 - “BK-IN” appears when semi break-in is selected.
- ③ Set the break-in delay time (the delay from transmit to receive).
 - ➔ Push [VOX/BK-IN] for 2 sec. to select break-in program mode.
 - ➔ Rotate the tuning dial to select the desired delay.
 - ➔ Push [MENU] or [VOX/BK-IN] to return to menu set 1.

☞ **NOTE:** When using a paddle, rotate [KEY SPEED] to adjust the keying speed.

B FULL BREAK-IN OPERATION

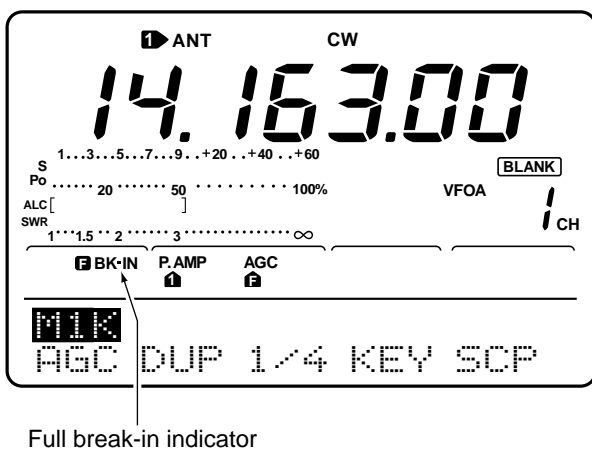

During full break-in operation, the transceiver automatically selects receive if a signal is detected while keying.

- ① Push [CW/RTTY] to select CW or CW-R mode.
 - ② Push [VOX/BK-IN] one or more times to select full break-in operation.
 - “BK-IN” appears when full break-in is selected.
- ☞ **NOTE:** When using a paddle, rotate [KEY SPEED] to adjust the keying speed.

6-3 ΔTX function

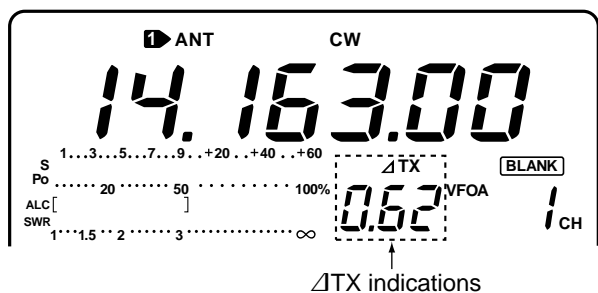
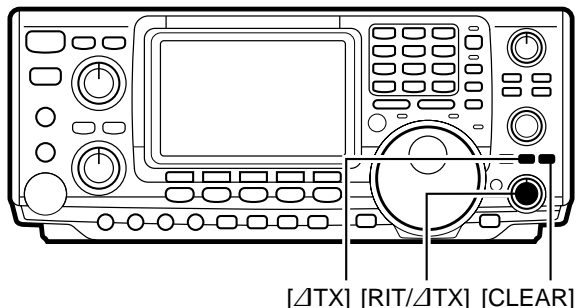

■ ΔTX MONITOR FUNCTION

The ΔTX functions shifts the transmit frequency up to ±9.99 kHz in 10 Hz steps without moving the receive frequency.

- ① Push [ΔTX] to toggle the ΔTX function ON and OFF.
 - “ΔTX” appears when the function is ON.
- ② Rotate the [RIT/ΔTX] control to set the desired ΔTX frequency.
 - Push [CLEAR] to set the ΔTX frequency to zero.
- ③ To cancel the ΔTX function, push [ΔTX] again.
 - “ΔTX” disappears.
 - To add or subtract the ΔTX frequency to the displayed frequency, push [ΔTX] for 2 sec.

When the ΔTX function is ON, pushing and holding [XFC] allows you to monitor the operating frequency directly (ΔTX is temporarily cancelled).

6-4 Monitor function

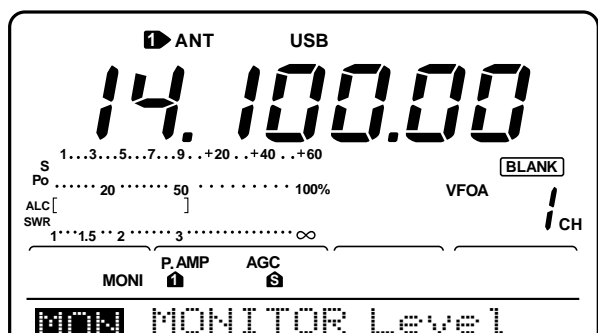
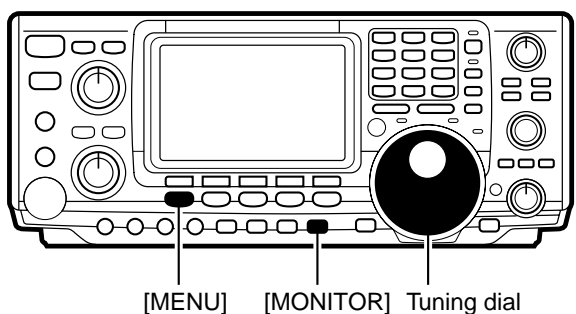

The monitor function allows you to adjust the quality of your transmitted signal for maximum readability.

- ① Push [MONITOR] to toggle the monitor function ON or OFF.
 - “MONI” appears when the function is ON.
- ② Set the monitor level.
 - ➔ Push [MONITOR] for 2 sec. to select monitor program mode.
 - ➔ Rotate the tuning dial for the clearest audio output while pushing [PTT] and speaking into the microphone.
- ③ Push [MENU] or [MONITOR] to return to menu set 1.

6-5 Speech compressor

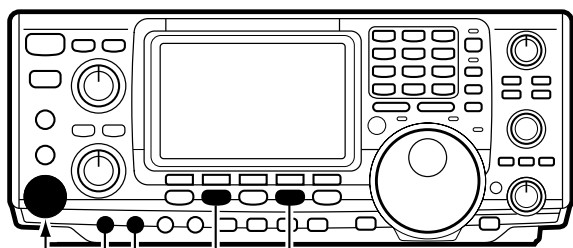

[SSB] [AM/FM]
[RF PWR]
[MIC GAIN]

Connect microphone here

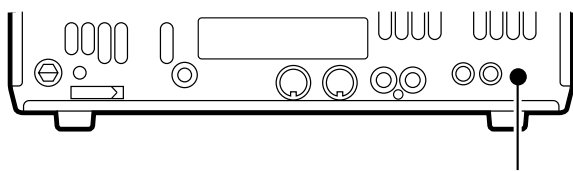

[COMP GAIN]

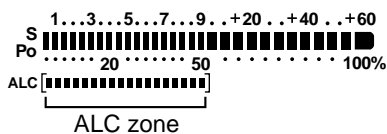

The RF speech compressor increases the average RF output power, improving signal strength and readability in SSB and AM modes.

- ① Push [SSB] or [AM/FM] to select SSB or AM mode.
- ② While menu set 1 is selected, push [F3](COMP) to turn the speech compressor ON.
 - "COMP" appears when the function is ON.
- ③ Set the [MIC GAIN] to the 9 to 12 o'clock position.
- ④ While speaking into the microphone, adjust [MIC GAIN] so that the ALC meter reads within the ALC zone whether you speak softly or loudly.
- ⑤ Use the monitor function (see previous page) to check that any distortion to your transmitted audio is at a minimum.

6-6 Split frequency operation

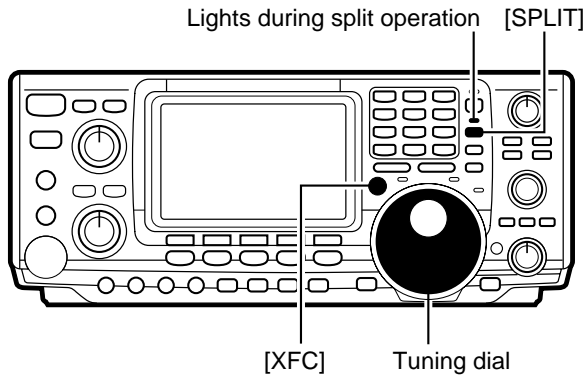

Split frequency operation allows you to transmit and receive in the same mode on two different frequencies, one in VFO A, the other in VFO B.

• Operation to step ②

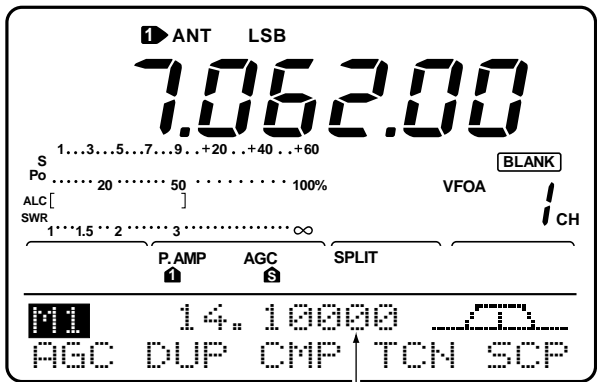

Push [SPLIT] to show VFO B contents

• Selecting VFO B

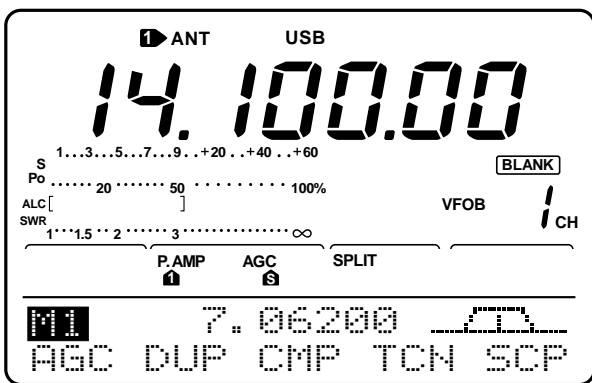

• Operation to step ③

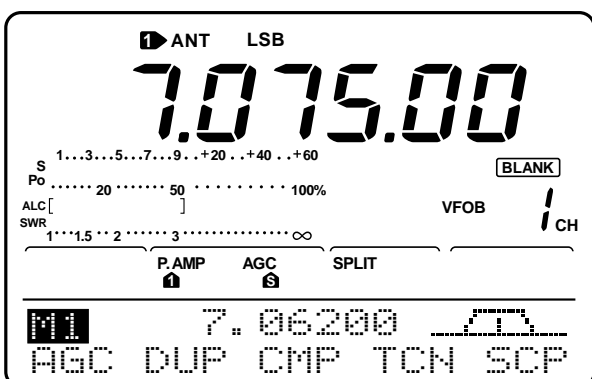

[EXAMPLE]: Operating split with VFO A set to receive 7.06200 MHz/LSB; VFO B set to transmit 7.07500 MHz/LSB.

- ① Set VFO A to 7.06200 MHz/LSB mode.
- ② Push [SPLIT] to turn split frequency operation ON.
 - “SPLIT” appears and the [SPLIT] indicator lights.
 - When split frequency operation is ON the function display indicates the transmit frequency.
- ③ Set VFO B to 7.07500 MHz/LSB.
 - ➔ While VFO A is displayed, push and hold [XFC], then rotate the tuning dial to set the frequency.
 - While pushing [XFC], the operating band and mode can be changed, if desired.
 - While pushing [XFC], the transmit frequency is monitored.

☞ **NOTE:** Cross band split operation may also be possible but is not guaranteed.

6-7 Quick split function

• Setting the frequency while pushing [XFC]

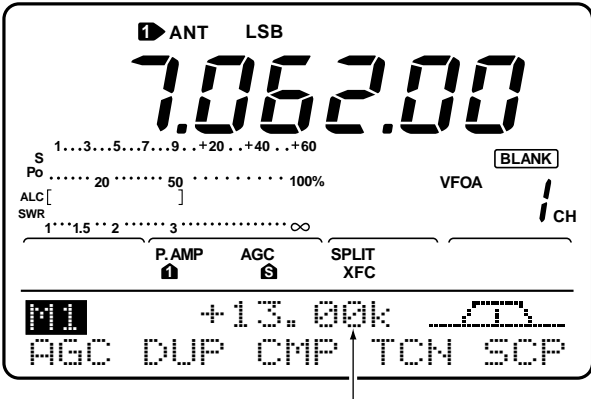

Indicates the difference between TX/RX frequencies

■ SPLIT OFFSET FREQUENCY SETTING

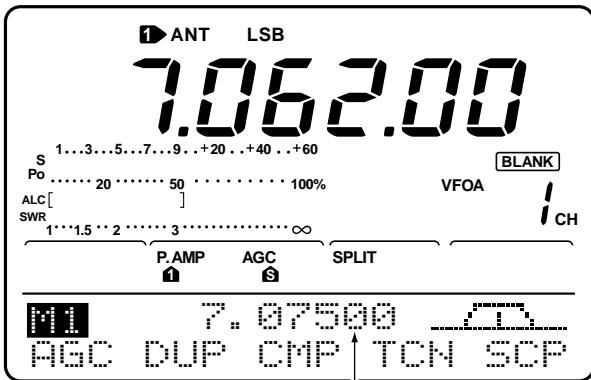

Indicates receive frequency for split operation

■ SPLIT LOCK FUNCTION

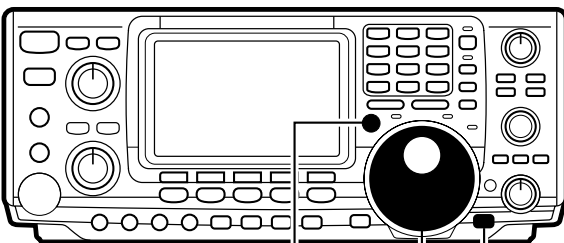
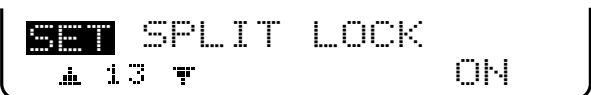

[XFC] Tuning dial [LOCK]

When you push [SPLIT] for 2 sec., split frequency operation is turned ON and VFO B is automatically changed according to the plus/minus shift frequency programmed in set mode (p. 61) or equalized when 0 kHz is programmed as the split shift frequency. Quick split operation is turned ON by default but can be turned OFF in set mode (p. 61).

- ① Push [SPLIT] for 2 sec. to turn split frequency operation ON.
 - VFO A and VFO B are equalized.
- ② While pushing [XFC], rotate the tuning dial to set the frequency offset between transmit and receive.
 - When [XFC] is released, the receive frequency is indicated.

By setting an often-used split frequency offset in advance, you can use the quick split function to select split operation at the push of one switch.

Set the split offset frequency in advance in set mode (p. 61, item 12). The example at left shows the split offset is set to +0.013 MHz.

- ➔ Push [SPLIT] for 2 sec. to activate the quick split function.
 - The receive frequency is offset from the transmit frequency according to the offset in set mode.

The split lock function is convenient for changing only the transmit frequency. When the split function is not used, accidentally releasing [XFC] while rotating the tuning dial, changes the receive frequency. The split lock function is ON by default, but can be turned OFF in set mode.

- ① While split frequency operation is ON, push [LOCK] to activate the split lock function.
- ② While pushing [XFC], rotate the tuning dial to change the transmit frequency.
 - If you accidentally release [XFC] while rotating the tuning dial the receive frequency does NOT change.

7-1 General

The transceiver has 101 memory channels (plus 1 call channel). Memory mode is useful for quickly changing often-used frequencies.

All 101 memory channels are tuneable, which means the programmed frequency can be tuned temporarily with the tuning dial in memory mode.

MEMORY CHANNEL	MEMORY CHANNEL NUMBER	CAPABILITY	TRANSFER TO VFO	OVER-WRITING	CLEAR
Regular (split memory)	1-99	Independent transmit and receive frequencies and one mode in each memory channel. In addition, tone frequencies (or 1750 Hz tone burst) can also be stored for repeater use.	Yes	Yes	Yes
Scan edges	P1, P2	One frequency and one mode in each memory channel as scan edges for programmed scan.	Yes	Yes	No
Call channel	C	Same as regular.	No	Yes	No

7-2 Memory channel selection

A IN VFO MODE

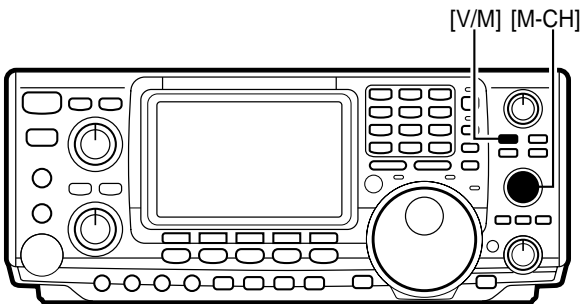

- ① Push [V/M] to select VFO mode, if necessary, then rotate [M-CH] to select a memory channel number.
 - All memory channels including blank channels can be selected.
 - “BLANK” appears when no information has been programmed into a memory channel.
- ② Push [V/M] to select memory mode.
 - “MEMO” and the contents of the memory channel appear.

• VFO mode is selected

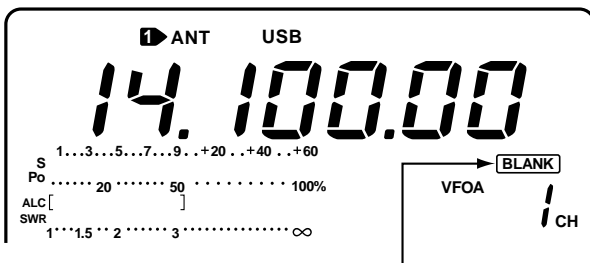

Disappears when a channel is programmed

• M-CH 2 is selected in VFO, then memory mode is selected

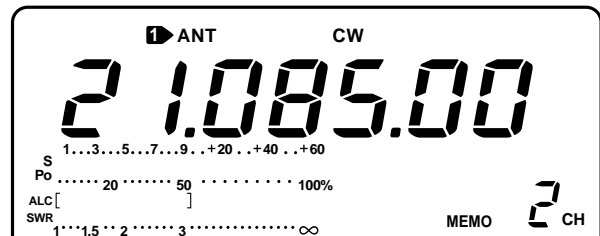

B IN MEMORY MODE

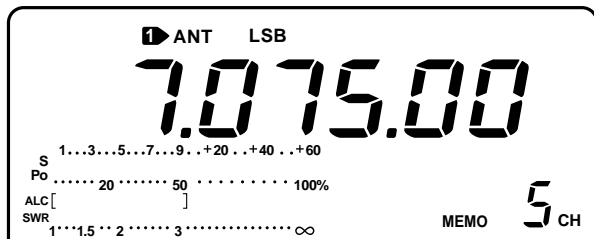

- ① Push [V/M] to select memory mode.
- ② Rotate [M-CH] to select a memory channel.
 - All memory channels including blank channels can be selected.
 - Memory channels can also be selected using the microphones [UP]/[DN] keys.

7-3 Transferring a memory to VFO

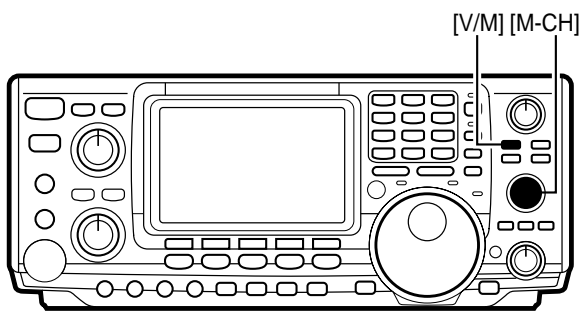

The contents of a memory channel (frequency, mode, etc.) can be transferred to VFO mode.

- ① Push [V/M] to select VFO mode, if necessary.
- ② Rotate [M-CH] to select the memory channel number to be transferred.
- ③ Push [V/M] for 2 sec. to transfer the contents of the selected memory channel to VFO mode.

• After transferring contents of M-CH 5 to VFO

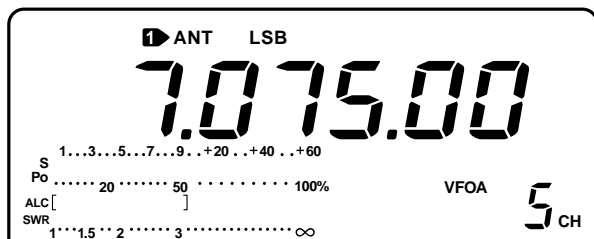

7-4 Clearing a memory

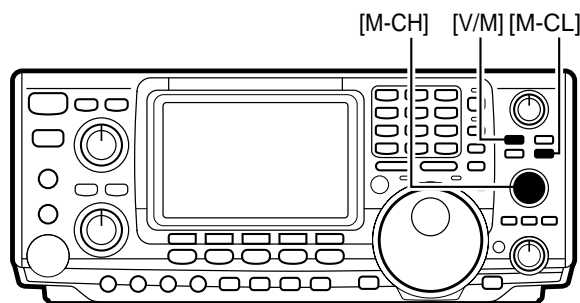

Any unnecessary memory channels can be cleared. The cleared memory channels become blank channels. The scan edge channels P1 and P2 and the call channel cannot be cleared.

- ① Push [V/M] to select memory mode, if necessary.
- ② Rotate [M-CH] to select the memory channel to be cleared.
- ③ Push [M-CL] for 2 sec. to clear the contents of the selected memory channel.
 - The contents of the memory are cleared and "BLANK" appears.

• After clearing the contents of M-CH 5

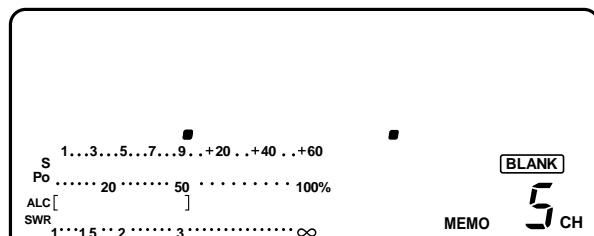

7-5 Selecting the call channel

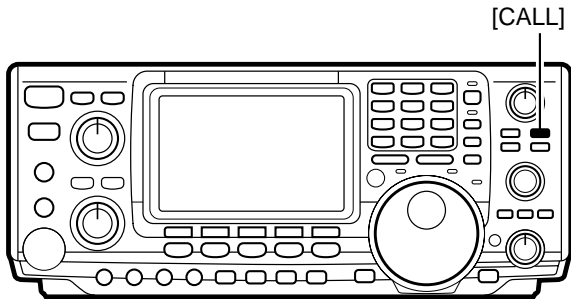

• After selecting the call channel

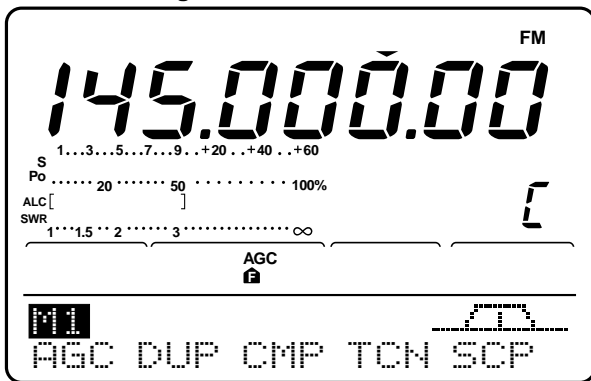

By default 145.00000 MHz/FM is programmed into the call channel. However, this can be changed to suit your operating preferences (p. 52).

- ① Push [CALL] to select the call channel.
 - "C" appears.
- ② Push [CALL] again to return to the previous mode.

☞ **NOTE:** When the call channel is selected via the call switch ([CALL]), the frequency CANNOT be changed using the tuning dial, band keys or by keypad input. However, when the call channel is selected using [M-CH] in memory mode, the frequency CAN be changed.

7-6 Programming a memory

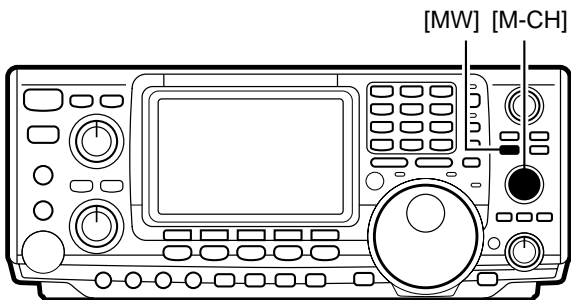

• After programming memory channel 10

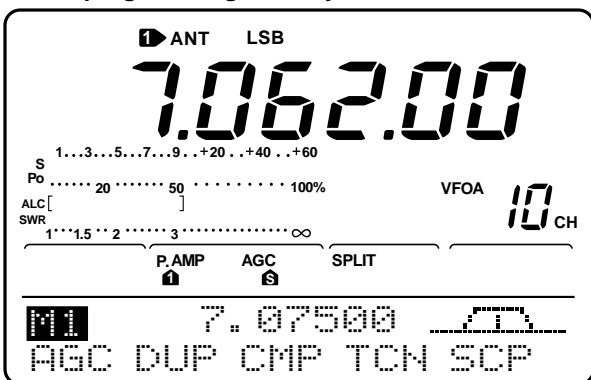

Memory channels 1 to 99 (as well as the call channel) can be programmed with independent transmit and receive frequencies. These are called split frequencies and are stored in VFO A and VFO B. In addition, operating mode, IF filter settings, tone frequencies and memory names can be stored.

[EXAMPLE]: programming 7.06200 MHz/LSB as a receive frequency and 7.07500 MHz/LSB as a transmit frequency into M-CH 10.

- ① Set frequency and operating mode as in split frequency operation (p. 47).
 - If split frequency operation is turned OFF in set mode (p. 61), only the displayed VFO's contents will be memorized.
- ② Rotate [M-CH] to select M-CH 10.
 - Select memory mode to confirm the contents, if desired.
 - "BLANK" appears if the selected memory channel is a blank channel (and does not have contents).
- ③ Push [MW] for 2 sec. to program the displayed frequency and operating mode into the memory channel.
 - To check the programmed contents, push [V/M] to select memory mode.

☞ **NOTE:** To program the VHF repeater frequency, program repeater input/output frequencies to VFO A and B. For the USA version, an auto repeater function is available to set duplex direction automatically.

7-7 Programming the call channel

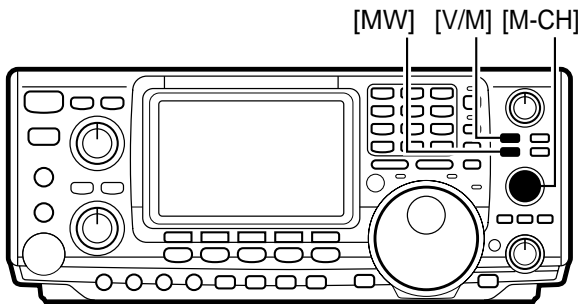

The call channel is programmed in the same way regular memory channels are. It's convenient to program a most-often-used frequency into the call channel for quick recall. As with memory channels, the call channel can also hold split frequencies.

- ① Rotate [M-CH] to select the call channel.
 - "C" appears.
- ② Select a frequency and operating mode to program into the call channel.
- ③ Push [MW] for 2 sec. to program the displayed frequency and operating mode into the call channel.

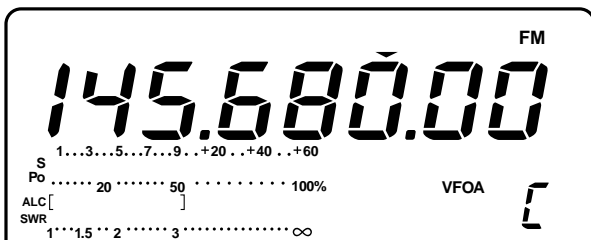

7-8 Programming scan edges

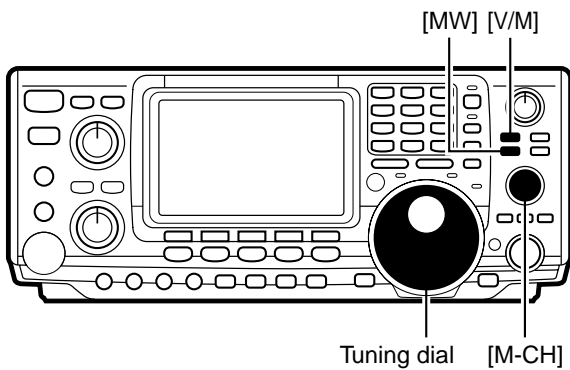

Memory channels P1 and P2 are the program scan edges. They are used to program an upper and lower frequency for programmed scan (p. 56). By default, P1 is programmed with 0.50000 MHz and P2 is programmed with 29.99999 MHz. If P1 and P2 are programmed with the same frequencies, programmed scan will not proceed.

[EXAMPLE]: Programming 14.00000 MHz into P1 and 14.35000 MHz into P2.

- ① Rotate [M-CH] to select scan edge P1.
- ② Rotate the tuning dial to set 14.00000 MHz as the lower frequency.
- ③ Push [MW] for 2 sec. to program 14.00000 MHz into scan edge P1.
- ④ Rotate [M-CH] to select scan edge P2.
- ⑤ Rotate the tuning dial to set 14.35000 MHz as the upper frequency.
- ⑥ Push [MW] for 2 sec. to program 14.35000 MHz into scan edge P2.
 - When programmed scan is activated (p. 56) scanning will search the frequencies between 14.00000 MHz and 14.35000 MHz for signals.

• After steps ① to ④

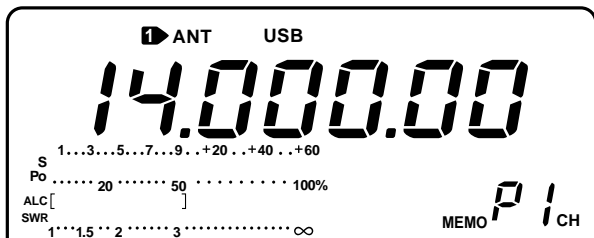

• After steps ⑤ to ⑦

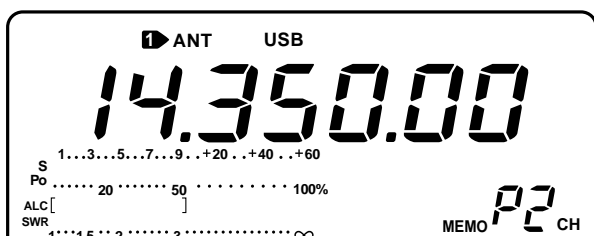

7-9 Assigning memory names

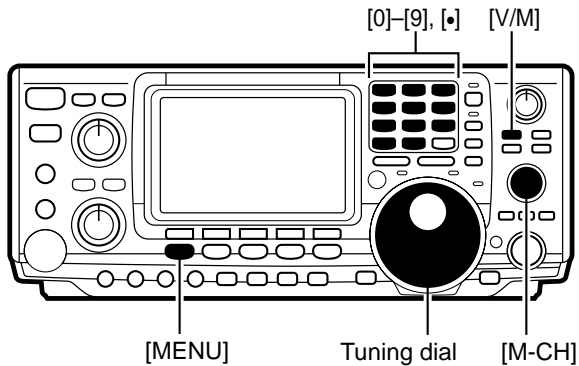

•After completing step ③

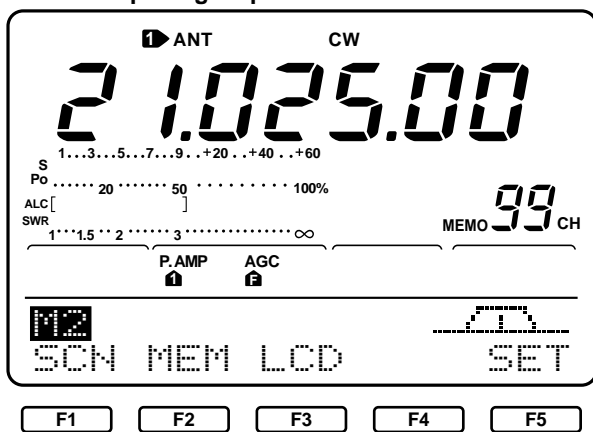

•After completing step ④

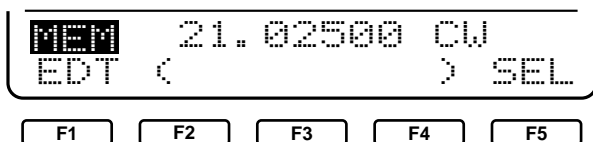

•After completing step ⑤

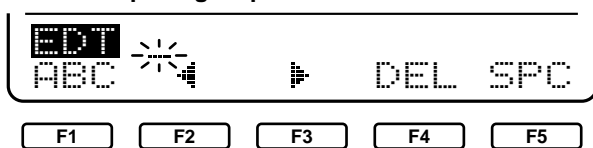

•After completing step ⑥

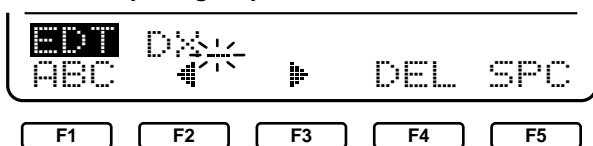

•After completing step ⑨



Memory names can be assigned to any memory channel. Memory names can be up to 9 characters in length; any of the 127 standard ASCII characters (as on a computer keyboard) can be used.

[EXAMPLE]: Programming “DX spot” into memory channel 99.

- ① Push [V/M] to select memory mode, if necessary.
- ② Rotate [M-CH] to select memory channel 99.
- ③ Push [MENU] to select menu set 2.
- ④ Push [F2](MEM) to select the memory name menu.
- ⑤ Push [F1](EDT) to select the memory edit menu.
- ⑥ Push [F1](ABC) one or more times to select the type of characters for input.
 - “ABC” inputs capital letters A to Z.
 - “abc” inputs small letters a to z.
 - “etc” is used to input other characters such as punctuation.
- ⑦ Rotate the tuning dial to select the first character for input.
- ⑧ Push [F3]() or [F2]() to move the cursor forwards or backwards, respectively.
 - [F5](SPC) inserts a space and [F4](DEL) deletes a character.
- ⑨ Repeat steps ⑥ to ⑧ to input the remainder of the name.
- ⑩ Push [MENU] to set the memory name and return to the memory name menu.
 - Push [MENU] 2 more times to return to menu set 1.

7-10 Memo pads

A WRITING FREQUENCIES AND OPERATING MODES INTO A MEMO PAD

The transceiver has a memo pad function to store frequency and operating mode for easy recall. The memo pads are separate from memory channels. The default number of memo pads is 5 but can be increased to 10 in set mode, if desired.

- ➔ Push [MP-W] to store the displayed frequency and operating mode into a memo pad.
 - Each push of [MP-W] stores a frequency and mode into the next available memo pad; when you write a 6th (or 11th) frequency and operating mode, the oldest written frequency and operating mode are automatically erased to make room for the new settings.

☞ **NOTE:** Each memo pad must have its own unique combination of frequency and operating mode; memo pads having identical settings cannot be written.

• Displayed frequency and mode

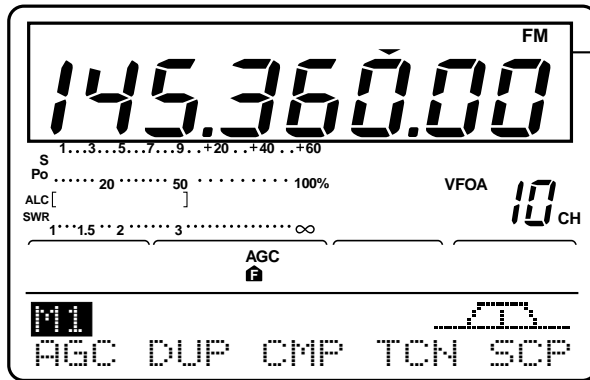

[MP-W]

• Stored in next available memo pad

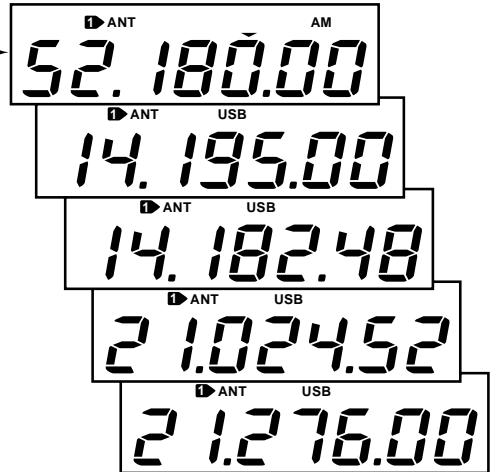

memo pad cleared

In this example, pushing [MP-W] enters FM 145.3600.00 MHz into the top memo pad and clears the oldest memo pad.

B RECALLING A MEMO PAD

- ➔ Push [MP-R] to recall a memo pad.
 - Each push of [MP-R] recalls a memo pad, starting from the most recently written.

• VFO or memory mode

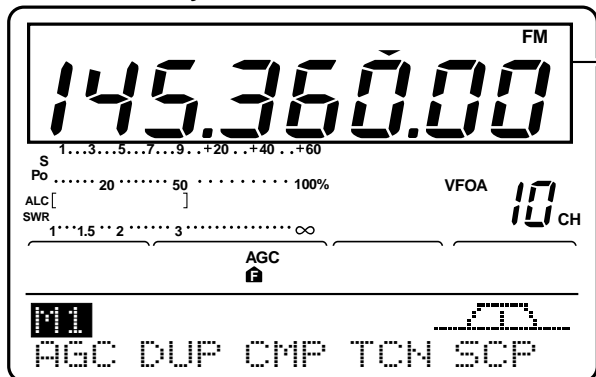

[MP-W]

• Memo pads

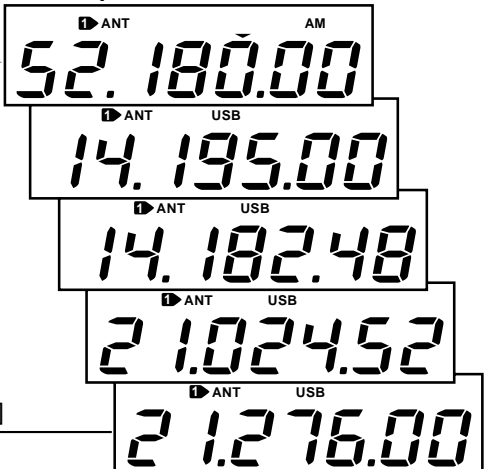

[MP-R]

8-1 Scan types

PROGRAMMED SCAN

Repeatedly scans between two scan edge frequencies (scan edge memory channels P1 and P2).

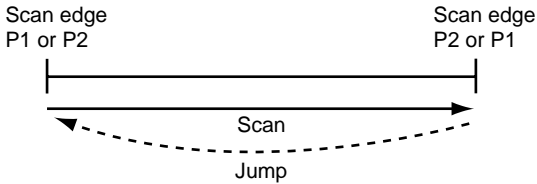

This scan operates in VFO mode.

ΔF SCAN

Repeatedly scans within ΔF span area.

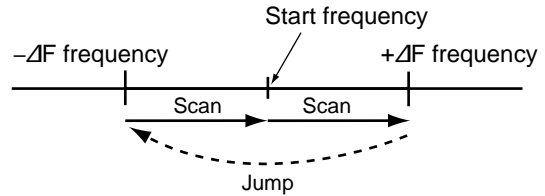

This scan operates in both VFO and memory modes.

MEMORY SCAN

Repeatedly scans all programmed memory channels.

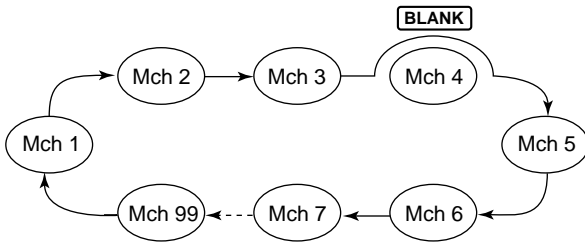

This scan operates in memory mode.

SELECT MEMORY SCAN

Repeatedly scans all select memory channels.

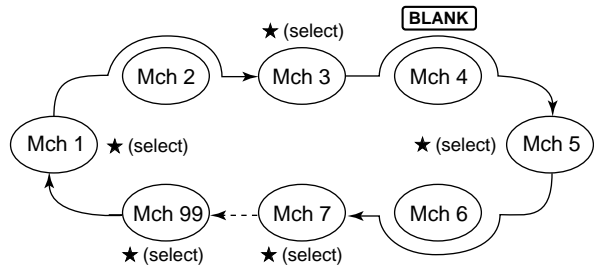

This scan operates in memory mode.

BEFORE SCANNING

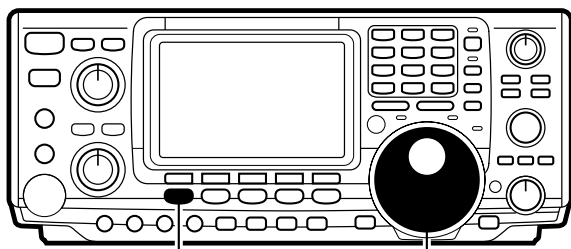

[MENU]

Tuning dial

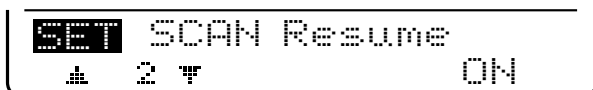
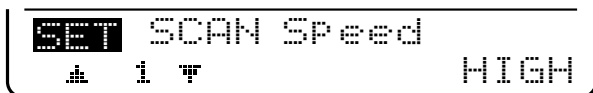
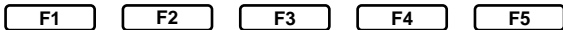

When the squelch is open, scan continues until it is stopped manually—it does not pause on detected signals. When the squelch is closed, scan stops when detecting a signal, then resumes according to the scan resume condition. Scan speed and the scan resume condition can be set using the scan set menu.

- ① Push [MENU] to select M2, if necessary.
- ② Push [F1] to select the scan menu.
- ③ Push [F5] to select the scan set menu.
- ④ Push [F1] or [F2] to select the desired item.
- ⑤ Rotate the tuning dial to select the desired condition for the displayed item (see below).
- ⑥ Push [MENU] 3 times to return to M1.

Scan speed can be set to LOW or HIGH.

- LOW: scan is slower.
- HIGH: scan is faster.

Scan resume can be set to OFF or ON.

- OFF: when detecting a signal, scan does not stop.
- ON: when detecting a signal scan pauses for 10 sec., then resumes. When a signal disappears, scan resumes 2 sec. after.

8-2 Programmed scan and fine programmed scan

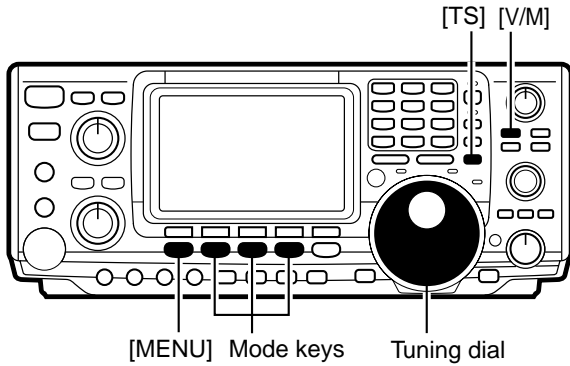

Programmed scan searches for signals between scan edge memory channels P1 and P2. The default frequencies for these memories are 0.500000 MHz and 29.99999 MHz, respectively. See p. 56 for programming scan edges.

- ① Push [V/M] to select VFO mode, if necessary.
- ② Push a mode key to select the desired operating mode.
 - Operating mode can also be selected during scan.
- ③ Push [TS] to select a tuning step.
 - Tuning steps can also be selected during scan.
- ④ Push [MENU] to select M2.
- ⑤ Push [F1] to select the scan menu.
- ⑥ Push [F1] to start/stop programmed scan.
 - The MHz and kHz decimal points flash during scan.
 - Rotating the tuning dial during scan cancels scan operation.

Menu 2

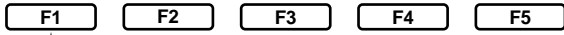
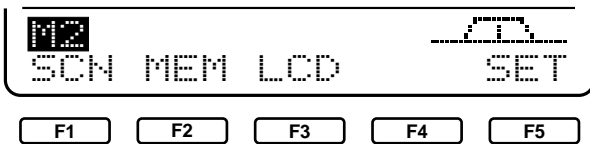

Push [F-1] to select the scan menu.

Scan menu

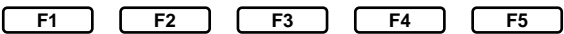
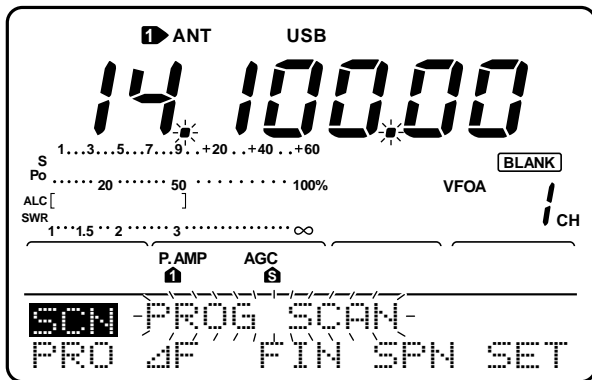

Push [F-1] to start/stop scan.

■ ABOUT FINE PROGRAMMED SCAN

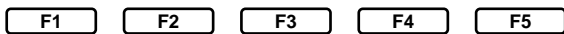

Push [F3] to toggle between program scan and fine program scan.

During programmed scan, when a signal is received, scan continues, but the tuning step is temporarily set to 10 Hz.

- ① Follow steps ① to ⑥ above to start programmed scan.
- ② During programmed scan, push [F3] to toggle between programmed scan and ΔF scan operation.
- ③ Push [F1] to stop the scan.

8-3 Memory scan

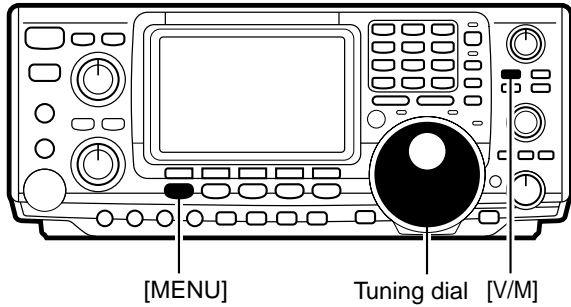

Memory scan searches through memory channel 1 to 99 for signals. Blank (unprogrammed) memory channels are skipped.

- ① Push [V/M] to select memory mode, if necessary.
- ② Push [MENU] to select M2.
- ③ Push [F1] to select the scan menu.
- ④ Push [F1] to start/stop memory scan.
 - The MHz and kHz decimal points flash during scan.
 - At least 2 memory channels must be programmed for memory scan to proceed.
 - Rotating the tuning dial during memory scan cancels the scan.

Scan menu

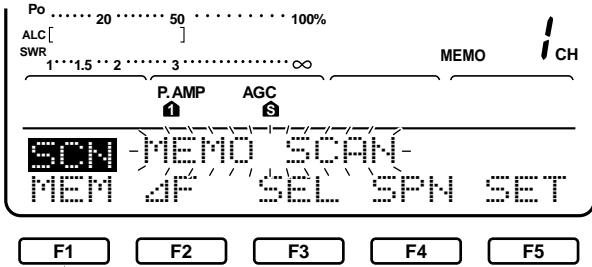

Push [F-1] to start/stop memory scan.

8-4 Select memory scan

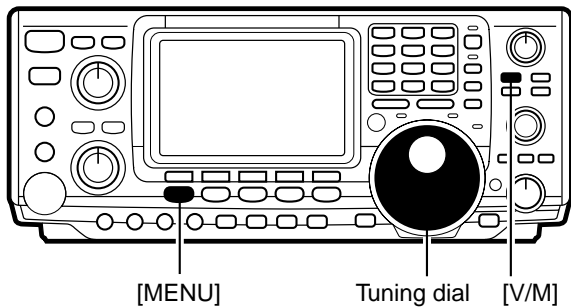

Select memory scan searches through memory channel set as "select" for signals. See below for setting/deleting select memory channels

- ① Follow the steps above to start memory scan.
- ② During memory scan, push [F3] to toggle between memory scan and select memory scan.
- ③ Push [F1] to stop the scan.
 - At least 2 memory channels must be programmed for memory scan to proceed.
 - Rotating the tuning dial during memory scan cancels the scan.

Scan menu

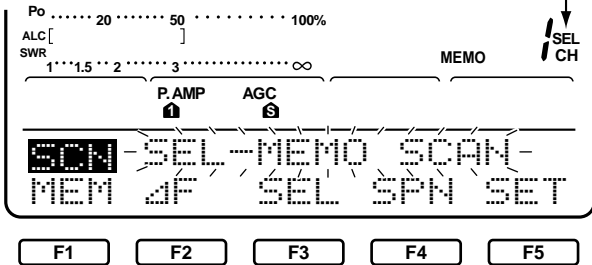

Push [F-3] to toggle between memory scan and select memory scan.

■ SETTING/DELETING SELECT MEMORY CHANNELS

All memory channels except scan edges (P1, P2) can be set as select memory channels.

While the scan menu is selected, push [F3] to toggle a memory channels select setting.

- "SEL" appears when a channel is set as a select channel.

8-5 Δ F scan and Fine Δ F scan

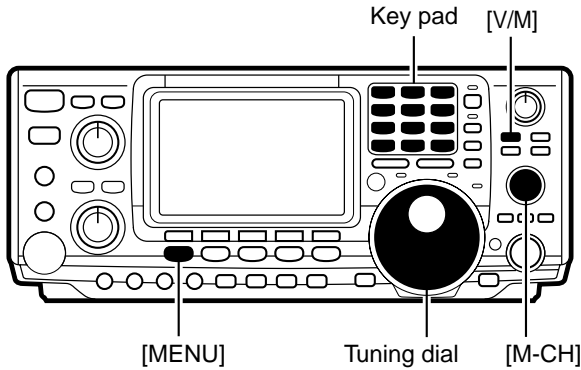

Δ F scan searches on either side of the displayed memory channel or frequency. The frequency range searched on either side of the center frequency (memory channel) is specified by the span.

- ① Push [V/M] to select memory mode or VFO mode, as desired.
- ② Push [MENU] to select M2.
- ③ Push [F1] to select the scan menu.
- ④ Push [F4] one or more times to select the desired span value.
 - Selectable span values are ± 5 kHz, ± 10 kHz, ± 20 kHz, ± 50 kHz, ± 100 kHz, ± 500 kHz and ± 1 MHz.
- ⑤ In VFO mode, use the keypad or tuning dial to set the center frequency; in memory mode, rotate [M-CH] to set the center frequency for memory channels.
- ⑥ Push [F2] to start/stop Δ F scan.
 - The MHz and kHz decimal points flash during scan.
 - Rotating the tuning dial during scan cancels the scan.

Menu 2



Push [F-1] to select the scan menu.

Scan menu

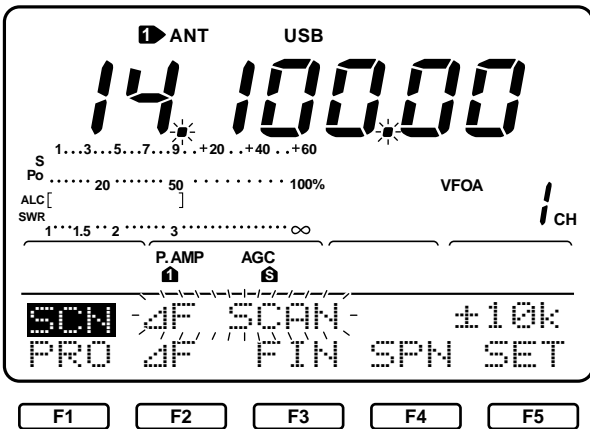

Push [F-3] to toggle between Δ F scan and fine Δ F scan.

■ ABOUT FINE Δ F SCAN

Scan menu



Push [F-3] to toggle between Δ F scan and Fine Δ F scan.

This is the same as Δ F scan, except that when a signal is detected, the scan tuning becomes 10 Hz.

- ① Follow steps ① to ⑥ above to start Δ F scan.
- ② During Δ F scan, push [F3] to toggle between Δ F scan and fine Δ F scan.
- ③ Push [F2] to cancel the scan.

9-1 Before operating

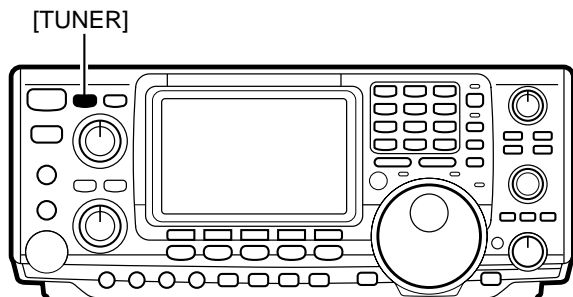

9-2 Tuner operation

■ MANUAL TUNING

■ NOTES

- The internal antenna tuner can only tune the HF and 50 MHz bands—the 144 MHz band cannot be tuned.
- DO NOT transmit if no antenna is connected to [ANT1] or [ANT2].
- When 2 antennas are connected, select the antenna to be used with [ANT].
- If the SWR is higher than about 1.5:1 when tuning above 100 kHz on an antenna's preset point, push [TUNER] for 2 sec. to start manual tuning.
- The internal tuner may not be able to tune in AM mode. In such cases, push [TUNER] for 2 sec. to manually tune.

The internal automatic antenna tuner matches the transceiver to the connected antenna automatically. Once the tuner matches an antenna, the variable capacitor angles are memorized as a preset point for each frequency range (100 kHz steps). Therefore, when you change the frequency range, the variable capacitors are automatically preset to the memorized point. (See p. 62—19 Auto tune.)

- ① Make sure that output power on the HF bands is higher than 8 W; on the 50 MHz band, higher than 15 W.
- ② Push [TUNER] to turn the internal antenna tuner ON. (See p. 3—⑤ RF POWER CONTROL.)
 - The antenna is tuned automatically when the SWR is higher than 1.5:1.
 - When the tuner is ON, "TUNER" appears in the display.

During SSB operation at low voice levels, the internal tuner may not be tuned correctly. In such cases, manual tuning is helpful.

- ➔ Push [TUNER] for 2 sec. to start manual tuning.
 - During manual tuning, "TUNE" flashes.
 - If the tuner cannot reduce the SWR to less than 1.5:1 after 20 sec. of tuning, [TUNE] disappears and "through" is selected.

■ IF THE TUNER CANNOT TUNE THE ANTENNA

- Check the unaltered antenna SWR (less than 3:1 for HF bands; less than 2.5:1 for 50 MHz band).
- Repeat manual tuning several times.
- Tune with a 50 Ω dummy load and re-tune the antenna.
- Turn power OFF and ON.
- Adjust the antenna cable length (this is effective for higher frequencies in some cases).
- Some antennas, especially for low bands, have a narrow band width. These antennas may not be tuned at the edge of their bandwidth, therefore, tune such an antenna as follows:

[EXAMPLE]: Suppose you have an antenna which has an SWR of 1.5:1 at 3.55 MHz and an SWR of 3:1 at 3.8 MHz.

- ① Push [TUNER] to turn the antenna tuner ON.
- ② Select CW mode.
- ③ Turn OFF the break-in function (p. 44).
- ④ Push [TRANSMIT] to set the transmit condition.
- ⑤ Set 3.55 MHz and key down.
- ⑥ Set 3.8 MHz and key up.
- ⑦ Push [TRANSMIT] to return to the receive condition.

10 SET MODE

10-1 Selecting set mode

Set mode is used for programming infrequently changed values or conditions of functions.

- ① Push [MENU] to select M2, if necessary.
- ② Push [F5] to enter set mode.
- ③ Push [F1] or [F2] to change the selected item.
 - Push and hold [F1] or [F2] to cycle through the available set mode items.
- ④ Rotate the tuning dial to set the desired condition for a selected item.
- ⑤ Push [MENU] 2 times to exit set mode and select M1.

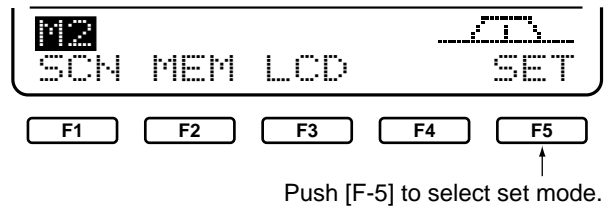
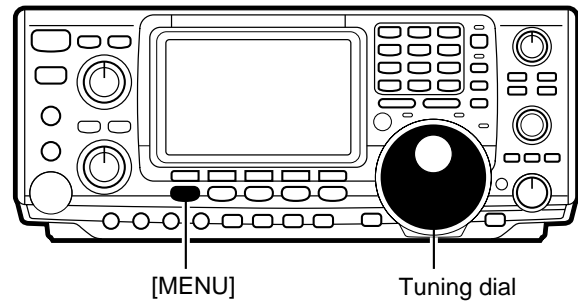

10-2 Set mode items

1. BeeP Level

This item sets the audio level for confirmation beep tones. The level is selectable from 0% to 100% in 1% steps. When beep tones (item 7) are turned OFF, this setting has no effect.



2. BeeP Level-Int

This item allows you to set a maximum volume level for confirmation beep tones. Confirmation beep tones are linked to the [AF] control until a specified volume level is reached—further rotation of the [AF] control will not increase the volume of the beep tones.



3. CaL. Marker

This item is used for a simple frequency check of the transceiver. See p. 65 for calibration procedures.

👉 **NOTE:** Turn the calibration marker OFF after checking the frequency of the transceiver.

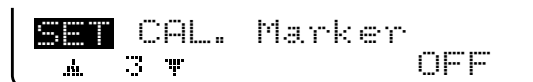

4. Filter (9MHz-1)

When an optional filter is installed in the 9 MHz filter socket (1), this selection is necessary, otherwise the filter cannot be selected.

FL-103, FL223, FL-100, FL-232 or FL-101 can be selected. See p. 42 for details.



5. Filter (9MHz-2)

When an optional filter is installed in the 9 MHz filter socket (2), this selection is necessary, otherwise the filter cannot be selected.

FL-103, FL223, FL-100, FL-232 or FL-101 can be selected. See p. 42 for details.

SET Filter (9MHz-2)
5 None

6. Filter (455kHz)

When an optional filter is installed in the 455 kHz filter socket, this selection is necessary, otherwise the filter cannot be selected.

FL-257, FL-96, FL-222, FL-52A or FL-53A can be selected. See p. 42 for details.

SET Filter (455kHz)
6 None

7. Beep

A beep sounds each time a switch is pushed to confirm it. This function can be turned OFF for silent operation. See item 1 for setting the volume level.

SET Beep
7 ON

8. Band Edge Beep

A beep sounds each when an operating frequency enters or exits an amateur band. This functions independent of the confirmation beep setting (above). See item 1 for setting the volume level.

SET Band Edge Beep
8 ON

9. RF/SQL UR Type

The [RF/SQL] control can be set as the RF/squelch control (default), the RF gain control only (squelch is fixed as open) or the squelch control only (RF gain is fixed at maximum).

SET RF/SQL UR Type
9 RF+SQL

10. Meter Peak Hold

This item turns the meter peak hold function ON and OFF. When set to ON, peak meter readings are displayed for about 0.5 sec.

SET Meter Peak Hold
10 ON

11. Quick SPLIT

When this item is set to ON, pushing [SPLIT] for 2 sec. activates the quick split function (p. 48).

SET Quick SPLIT
11 ON

12. SPLIT Offset

This item sets the offset (difference between transmit and receive frequencies) for the quick split function. The offset can be set from -4 MHz to +4 MHz in 1 kHz steps.

SET SPLIT Offset
12 0.000MHz

10 SET MODE

13. SPLIT LOCK

When this item is ON, the tuning dial can be used to adjust the transmit frequency while pushing [XFC] even while the lock function is activated. See p. 47 for split frequency operation details.

```
SET SPLIT LOCK
┆ 13 ▼ OFF
```

14. DUP Offset HF

This item sets the offset (difference between transmit and receive frequencies) for the quick split function when operating on an HF band in FM mode only. This is used to input the repeater offset for an HF band. The offset frequency can be set from -4 MHz to +4 MHz in 1 kHz steps.

```
SET DUP Offset HF
┆ 14 ▼ 0.100MHz
```

15. DUP Offset 50M

This item sets the offset (difference between transmit and receive frequencies) for the quick split function when operating on the 50 MHz band in FM mode only. This is used to input the repeater offset for the 50 MHz band. The offset frequency can be set from -4 MHz to +4 MHz in 1 kHz steps.

```
SET DUP Offset 50M
┆ 15 ▼ 0.500MHz
```

16. DUP Offset 144M

This item sets the offset (difference between transmit and receive frequencies) for the quick split function when operating on the 144 MHz band in FM mode only. This is used to input the repeater offset for the 144 MHz band. The offset frequency can be set from -4 MHz to +4 MHz in 1 kHz steps.

```
SET DUP Offset 144M
┆ 16 ▼ 0.600MHz
```

17. One Touch Rptr

This item turns the one touch repeater function ON (+duplex or -duplex) and OFF. See p. 34 for details concerning the one touch repeater function.

```
SET One Touch Rptr
┆ 17 ▼ DUP-
```

18. Auto Repeater (USA only)

This item sets the auto repeater function to ON-1 (auto duplex setting), ON-2 (auto duplex setting and activating tone encoder) or OFF. See p. 35 for details concerning the auto repeater function.

```
SET Auto Repeater
┆ 18 ▼ OFF
```

19. Auto Tune

The internal antenna tuner has an automatic start capability which starts tuning if the SWR is higher than 1.5-3 in the HF bands.

When "OFF" is selected, the tuner remains OFF even when the SWR is poor (1.5-3). When "ON" is selected, automatic tune starts even when the tuner is turned OFF.

```
SET Auto Tune
┆ 19 ▼ OFF
```

20. PTT Tune

Tuning of the external antenna tuner can be started automatically at the moment the PTT is pushed after is the operating frequency is changed (more than 1% from the last-tuned frequency).

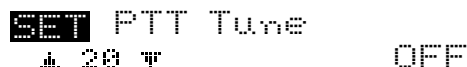

SET PTT Tune
 ▾ 20 ▸ OFF

21. ANT Select

You can set the antenna connector selection to automatic, manual or non-selection (when using 1 antenna only).

When "AUTO" is selected, the antenna switch is activated and the band memory memorizes the selected antenna. See p. 71 for details.

When "MANUAL" is selected, the antenna switch is activated and selects an antenna manually.

When "OFF" is selected, the antenna switch is not activated and does not function. The [ANT1] connector is always selected in this case.

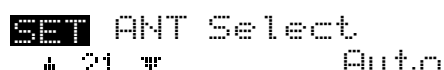

SET ANT Select
 ▾ 21 ▸ Auto

22. SPEECH Language

When the optional UT-102 VOICE SYNTHESIZER UNIT is installed, you can select between English and Japanese as the language. See p. 77 for unit installation.



SET SPEECH Language
 ▾ 22 ▸ English

23. SPEECH Speed

When the optional UT-102 VOICE SYNTHESIZER UNIT is installed, you can select between faster or slower synthesizer output. See p. 77 for unit installation.



SET SPEECH Speed
 ▾ 23 ▸ HIGH

24. SPEECH S-Level

When the optional UT-102 VOICE SYNTHESIZER UNIT is installed, you can have frequency, mode and signal level announcement. Signal level announcement can be deactivated, if desired. See p. 77 for unit installation.



SET SPEECH S-Level
 ▾ 24 ▸ ON

25. Memory Pad Ch

This item sets the number of memo pad channels available. 5 or 10 memo pads can be set.

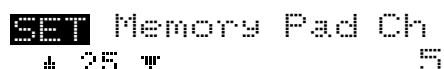

SET Memory Pad Ch
 ▾ 25 ▸ 5

10 SET MODE

26. MIC U/D Speed

This item sets the rate at which frequencies are scanned when the microphone [UP]/[DN] switches are pushed and held. High or low can be selected.

```
SET MIC U/D Speed
└─ 26 ▼ HIGH
```

27. CI-V Baud Rate

This item sets the data transfer rate. 300, 1200, 4800 9600, 19200 bps and "AUTO" are available.

When "AUTO" is selected, the baud rate is automatically set according to the connected controller or remote controller.

```
SET CI-V Baud Rate
└─ 27 ▼ Auto
```

28. CI-V Address

To distinguish equipment, each CI-V transceiver has its own Icom standard address in hexadecimal code. The IC-746's is 56h.

When 2 or more IC-746's are connected to an optional CT-17 LEVEL CONVERTER, rotate the tuning dial to select a different address for each IC-746 in the range 01h to 7Fh.

```
SET CI-V Address
└─ 28 ▼ 56h
```

29. CI-V Transceive

Transceive operation is possible with the IC-746 connected to other Icom HF transceivers or receivers.

When "ON" is selected, changing the frequency, operating mode, etc. on the IC-746 automatically changes those of connected transceivers (or receivers) and vice versa.

```
SET CI-V Transceive
└─ 29 ▼ ON
```

30. CI-V with 731

When connecting the IC-746 to the IC-735 for transceive operation, you must change the operating frequency data length to 4 bytes.

- This item must be set to "ON" only when operating transceive with the IC-735.

```
SET CI-V 731 Mode
└─ 30 ▼ OFF
```

11-1 Tuning dial brake

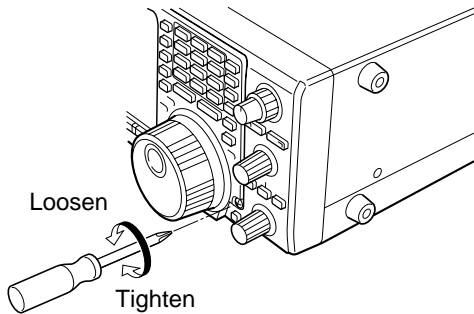

The tension of the tuning dial can be adjusted to suit your preference.

The brake adjustment screw is located on the right side of the tuning dial. See figure at left.

➔ Turn the brake adjustment screw clockwise or counterclockwise to obtain a comfortable tension level while tuning the dial continuously and evenly in one direction.

11-2 Frequency calibration

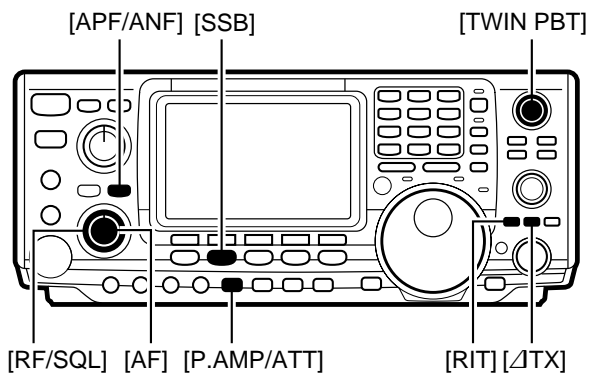

Setting the calibration marker

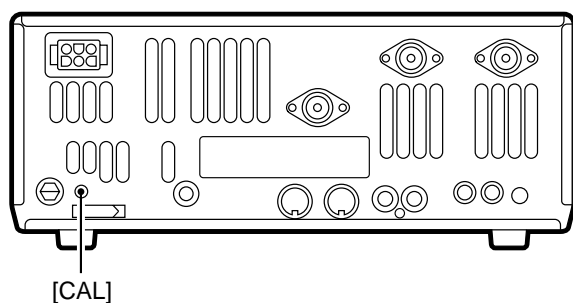
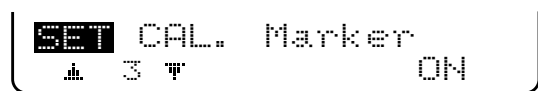

A very accurate frequency counter is required to calibrate the frequency of the transceiver. However, a rough check may be performed by receiving radio station WWV, or other standard frequency signals.

▼ **CAUTION:** Your transceiver has been thoroughly adjusted and checked at the factory before being shipped. You should not calibrate frequencies, except for special reasons.

- ① Push [SSB] to select USB mode. Make sure the [TWIN PBT] controls are set to the center position and the RIT/ΔTX function is not activated.
- ② Set the frequency to the standard frequency station minus 1 kHz.
 - When receiving WWV (10.000.00 MHz) as a standard frequency, set the operating frequency for 9.999.00 MHz.
 - Other standard frequencies can also be used.
- ③ Select [CAL. Marker] in set mode (p. 60) and set to ON.
- ④ Adjust the calibration pot [CAL] on the rear side of the transceiver for a zero beat with the received standard signal.
 - Zero beat means that two signals are exactly the same frequency, resulting in a single tone being emitted.
- ⑤ When calibration is complete, set [CAL. Marker] in set mode to OFF.

11-3 Measuring SWR

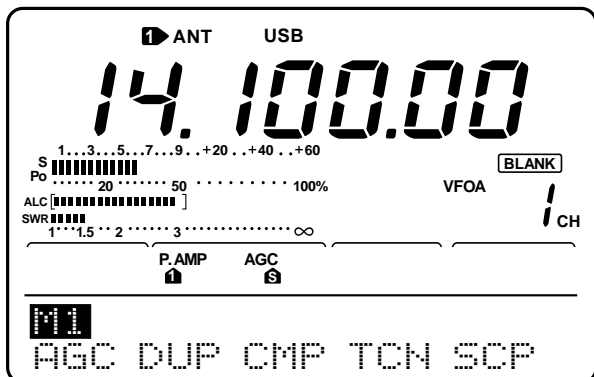

SWR meter

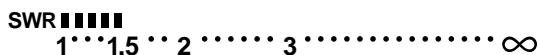

The IC-746 has a built-in circuit for measuring antenna SWR while in SSB mode — no external equipment or special adjustments are necessary.

Make sure the antenna whose SWR you want to measure is connected, that output power is set to 30 W or more and that [TUNER] is OFF.

➔ While pushing [PTT], speak (a single, even pitch) into the microphone.

- The measured SWR appears in the display.
- When the SWR reads higher than 1.5, antenna adjustment is necessary.

11-4 Adjusting the LCD

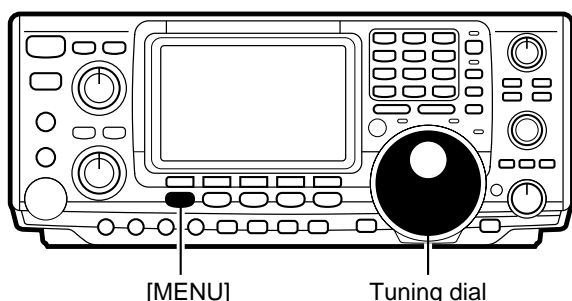

Menu 2

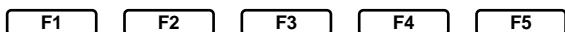
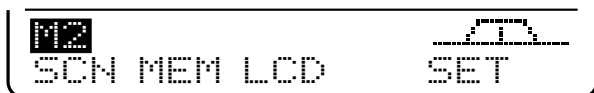

Push [F-3] to select the LCD menu.

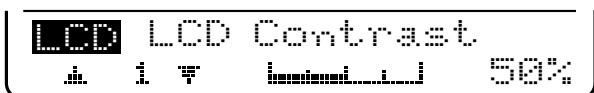

The function display backlighting and contrast can both be adjusted to suit your preference and to provide optimum readability under varying lighting conditions.

- ① Push [MENU] to select menu set 2.
- ② Push [F3](LCD) to select the LCD menu.
- ③ Push [F1] or [F2] to select the desired item to set.
- ④ Rotate the tuning dial to select the desired condition.
- ⑤ Push [MENU] 2 times to return to menu set 1.

The LCD contrast can be adjusted from 0% (lowest contrast) to 100% (highest contrast) in 1% steps.

- The default (shown at left) is 50%,

The LCD backlighting can be adjusted from 0% (darkest) to 100% (brightest) in 1% steps.

- The default (shown at left) is 50%,

12-1 Front panel

ELECTRONIC KEYS

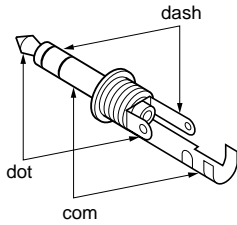

When using the internal electronic keyer connect a paddle.

HEADPHONES

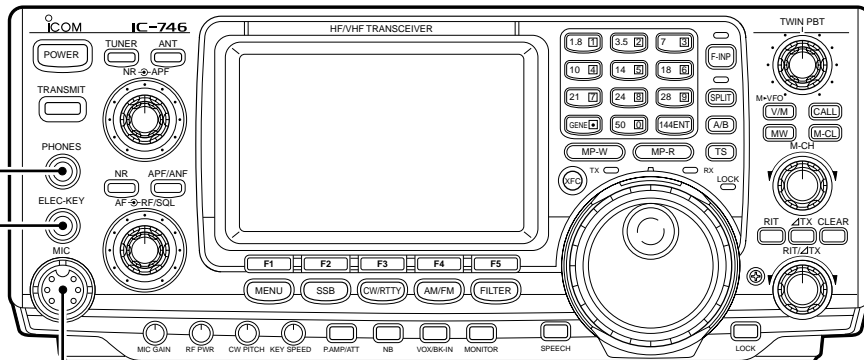
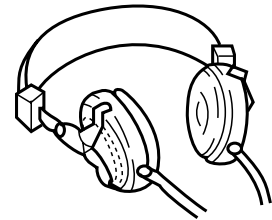

MICROPHONES

HM-36

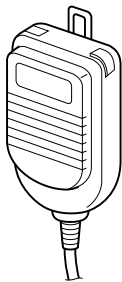

SM-20

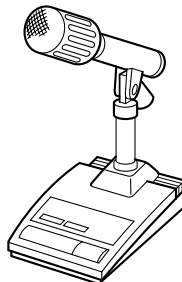

CONNECTOR INFORMATION (front panel view)

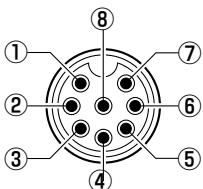

- ① MIC input
- ② +8 V DC output
- ③ Frequency up/down
- ④ Main readout squelch switch
- ⑤ PTT
- ⑥ GND (PTT)
- ⑦ GND (MIC)
- ⑧ AF OUT (varies with [AF])

TRANSCEIVER FEET

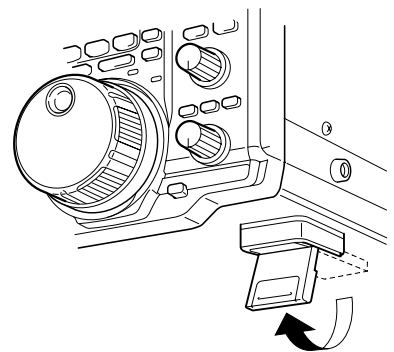

12-2 Rear panel

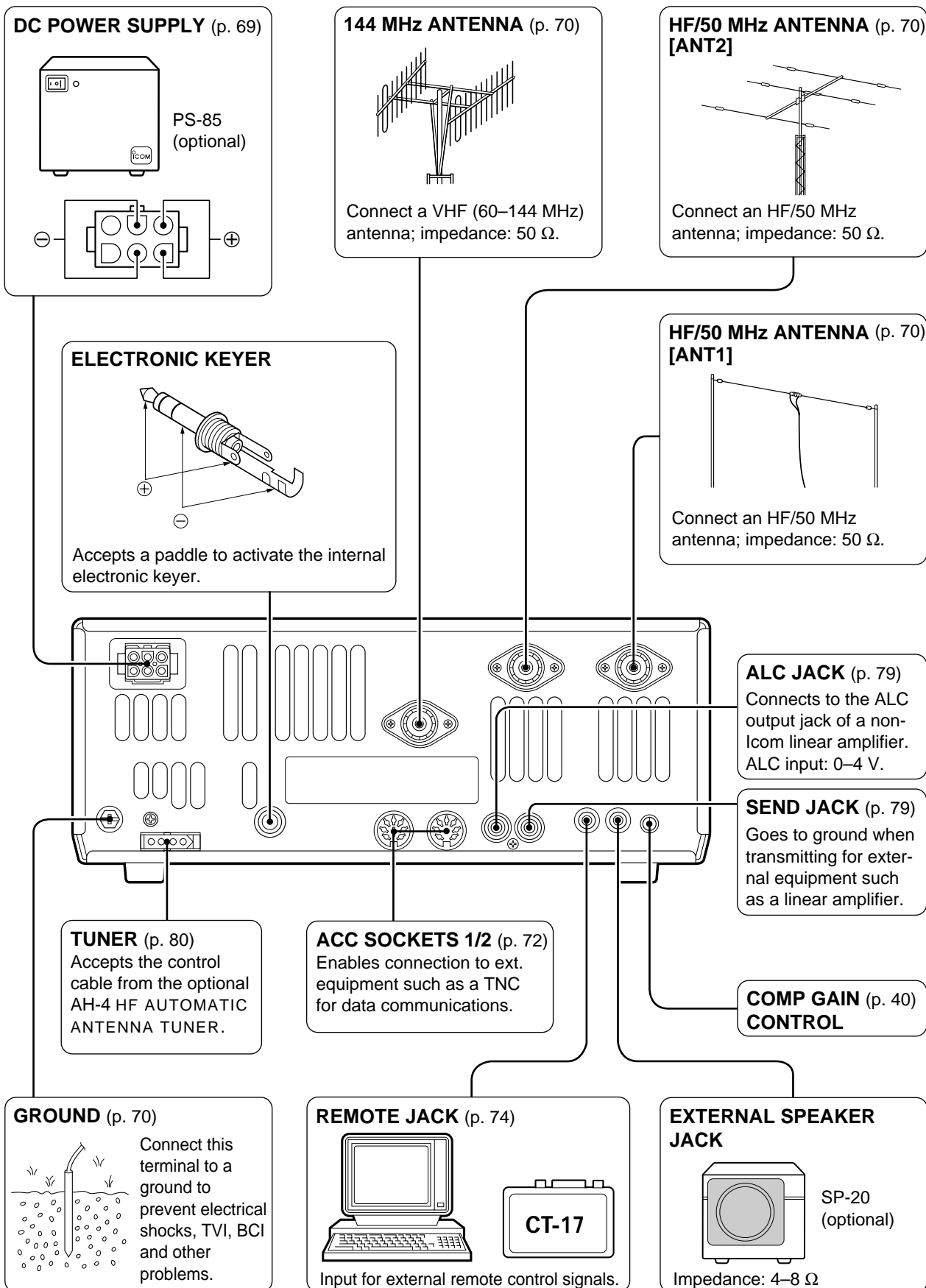

12-3 Selecting a location

Select a location for the transceiver that allows adequate air circulation, free from extreme heat, cold, or vibrations, and away from TV sets, TV antenna elements, radios and other electro-magnetic sources.

12-4 Power supply connections

Use an optional PS-85 DC POWER SUPPLY or non-Icom power supply, etc. when operating the transceiver with AC power. Refer to the diagrams below.

CAUTION: Before connecting the DC power cable, check the following important items. Make sure:

- The [POWER] switch is OFF.
- Output voltage of the power source is 12–15 V when you use a non-Icom power supply.
- DC power cable polarity is correct.

Red: positive ⊕ terminal
 Black: negative ⊖ terminal

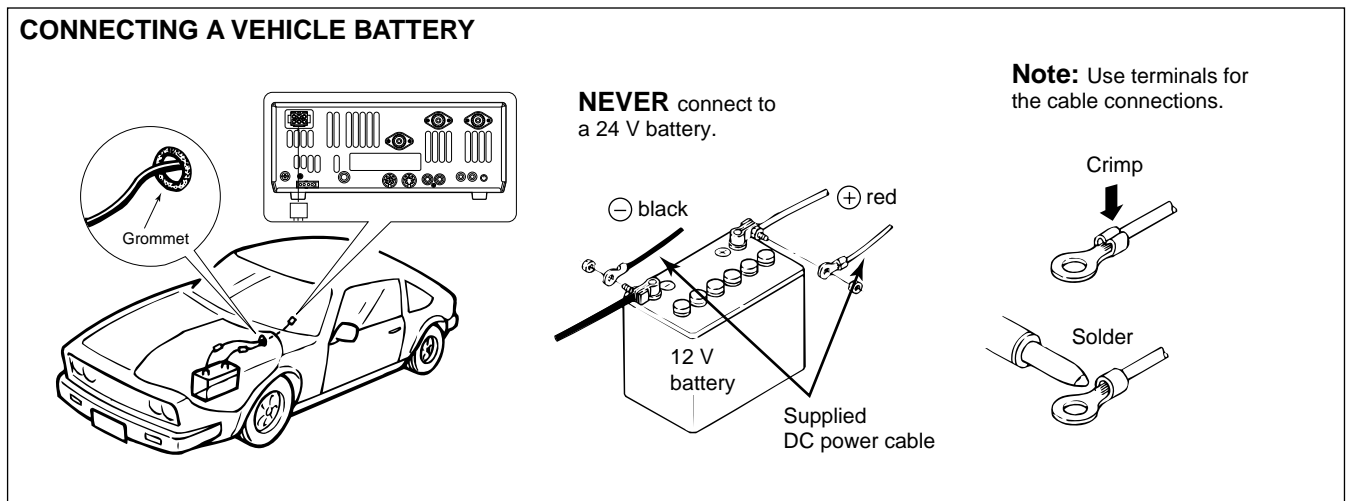
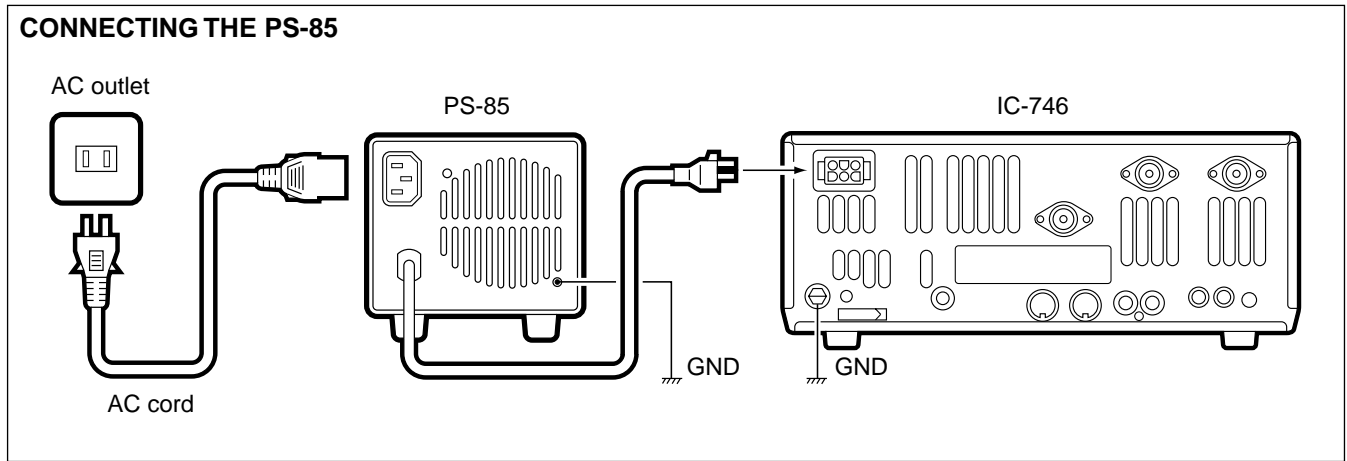

12-5 Grounding

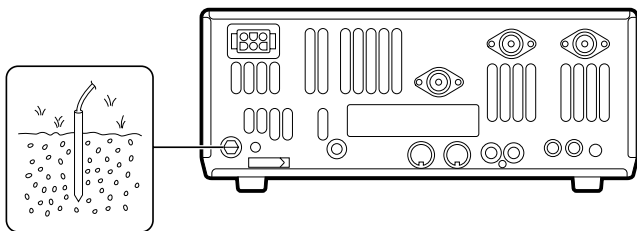

To prevent electrical shock, television interference (TVI), broadcast interference (BCI) and other problems, ground the transceiver through the GROUND terminal on the rear panel.

For best results, connect a heavy gauge wire or strap to a long earth-sunk copper rod. Make the distance between the GROUND terminal and ground as short as possible.

▼ CAUTION: NEVER connect the [GND] terminal to a gas or electrical pipe, since the connection could cause an explosion or electric shock.

12-6 Antenna

Select antenna(s), such as a well-matched 50 Ω antenna, and feedline. The transmission line should be a coaxial cable. 1.5:1 or better of Voltage Standing Wave Ratio (VSWR) is recommended for your required band. Of course, the transmission line should be a coaxial cable.

When using 1 antenna, use the [ANT1] connector.

▼ CAUTION: Protect your transceiver from lightning by using a lightning arrestor.

ANTENNA SWR

Each antenna is tuned for a specified frequency range and SWR may be increased out-of-range. When the SWR is higher than approx. 2.0:1, the transceiver's power drops to protect the final transistors. In this case, an antenna tuner is useful to match the transceiver and antenna. Low SWR allows full power for transmitting even when using the antenna tuner. The IC-746 has a SWR meter to monitor the antenna SWR continuously.

PL-259 CONNECTOR INSTALLATION EXAMPLE

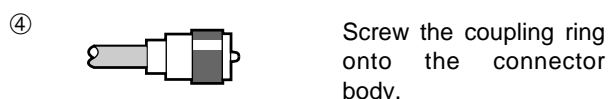
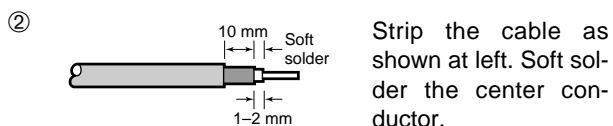
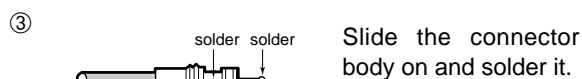
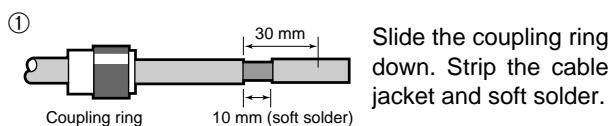

(10 mm ≈ 3/8 in)

■ ANTENNA SELECT FUNCTION (see p. 63)

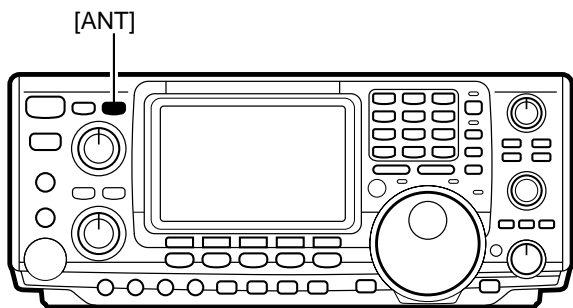

The IC-746 has 2 antenna connectors for the HF/50 MHz bands, [ANT1] and [ANT2], and 1 antenna connector for the 144 MHz band; a total of 3 antenna connectors.

For each operating band the IC-746 covers, there is a band memory which can memorize a selected antenna. When you change the operating frequency beyond a band, the previously used antenna is automatically selected (see below) for the new band. This function is convenient when you use more than 1 antenna.

ANTENNA SELECT FUNCTION: "Auto"

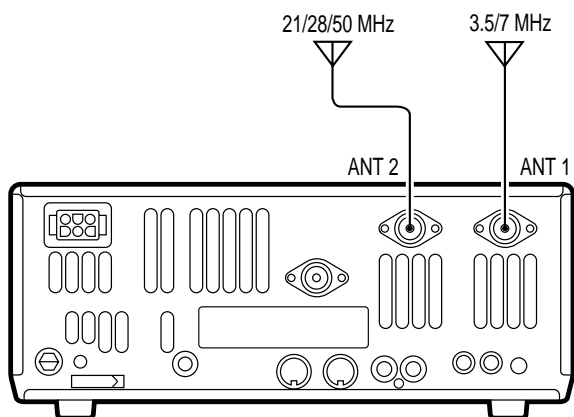

Once an antenna has been selected for use with a band by pushing [ANT], the antenna is automatically selected whenever that band is accessed.

[EXAMPLE]: a 3.5/7 MHz antenna is connected to [ANT1], a 21/28/50 MHz antenna is connected to [ANT2]. When the antenna selector function is set to "Auto," an antenna is automatically selected when changing bands.

ANTENNA SELECT FUNCTION: "Manual"

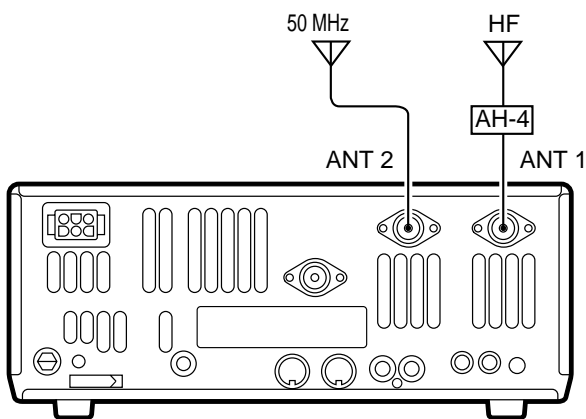

When "Manual" is selected, you can use the [ANT1]/[ANT2] switches, however, band memory does not function. In this case you must select an antenna manually. However, the 144 MHz antenna will still be selected automatically.

[EXAMPLE]: an optional external antenna tuner and HF antenna are connected to [ANT1] and a 50 MHz antenna is connected to [ANT2].

ANTENNA SELECT FUNCTION: "OFF"

In this case, only [ANT1] and the 144 MHz antenna connector can be used. [ANT] does not function.

12-7 Data communications

The IC-746 can be connected to AMTOR/PACKET or AFSK teletype units via the rear panel ACC sockets or the front panel [MIC] connector. When using such units be sure to consult the appropriate manuals.

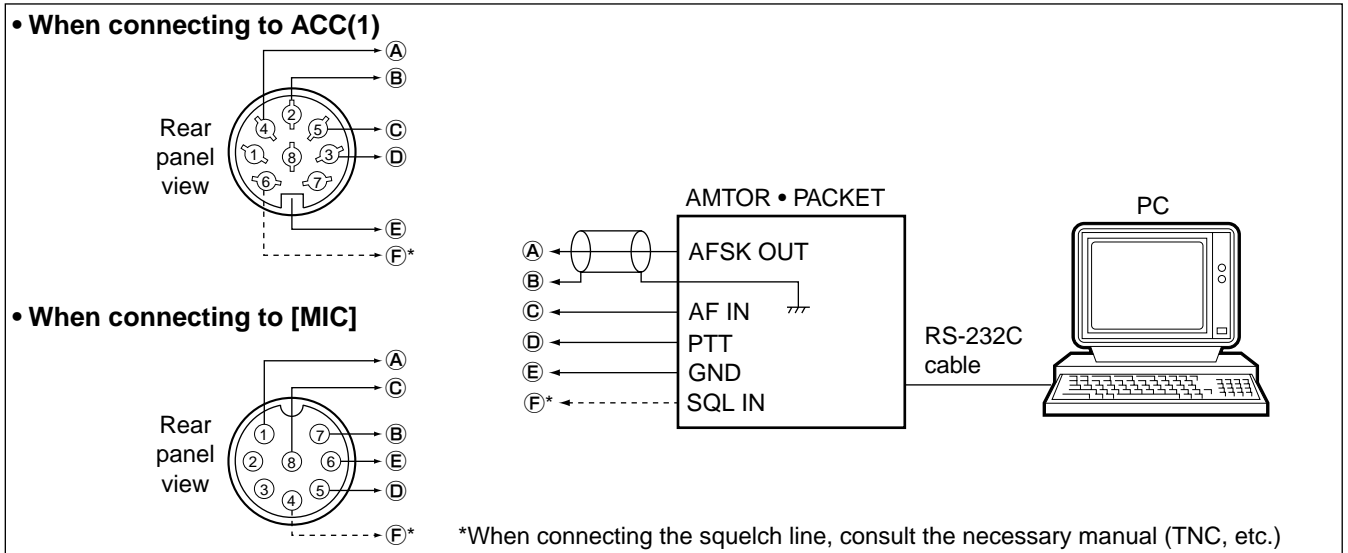

ACC(1)	PIN NO.	NAME	DESCRIPTION	SPECIFICATIONS
<p>Rear panel view</p>	1	RTTY	Controls RTTY keying.	"HIGH" level : More than 2.4 V "LOW" level : Less than 0.6 V Output current : Less than 2 mA
	2	GND	Connects to ground.	Connected in parallel with ACC(2) pin 2.
	3	HSEND	Input/output pin (HF/50 MHz only). Goes to ground when transmitting. When grounded, transmits.	Ground level : -0.5 V to 0.8 V Output current : Less than 20 mA Input current (Tx) : Less than 200 mA Connected in parallel with ACC(2) pin 3.
	4	MOD	Modular input Connects to a modulator	Input impedance : 10 kΩ Input level : Approx. 100 mV rms
	5	AF	AF detector output Fixed regardless of [AF] position.	Output impedance : 4.7 kΩ Output level : 100 to 300mV rms
	6	SQLS	Squelch output. Goes to ground when squelch opens	Squelch open : Less than 0.3 V/5 mA Squelch closed : More than 6.0 V/100 μA
	7	13.8 V	13.8 V output when power is ON.	Output current : Max. 1 A Connected in parallel with ACC(2) pin 7.
	8	ALC	ALC voltage input.	Control voltage : -4 to 0 V Input impedance : More than 10 kΩ Connected in parallel with ACC(2) pin 5.

ACC(2)	PIN NO.	NAME	DESCRIPTION	SPECIFICATIONS
<p>Rear panel view</p>	1	8 V	Regulated 8 V output.	Output voltage : 8 V ±0.3 V Output current : Less than 10 mA
	2	GND		Same as ACC(1) pin 2.
	3	HSEND		Same as ACC(1) pin 3.
	4	BAND	Band voltage output. (Varies with amateur band)	Output voltage : 0 to 8.0 V
	5	ALC		Same as ACC(1) pin 8.
	6	VSEND	Input/output pin (144 MHz only) Goes to ground when transmitting. When grounded, transmits.	Ground level : -0.5 V to 0.8 V Output current : Less than 20 mA
	7	13.8 V		Same as ACC(1) pin 7.

12-8 RTTY connections

When operating RTTY, a teletype and demodulator, etc. must be connected as in the diagrams below. The demodulator operates via audio input with a receive tone of 2125 Hz (or 1275 or 1615) and a shift offset of 170 Hz (or 200 or 425 Hz). See p. 29 for details on how to change the receive tone or shift offset.

• When using a high speed relay

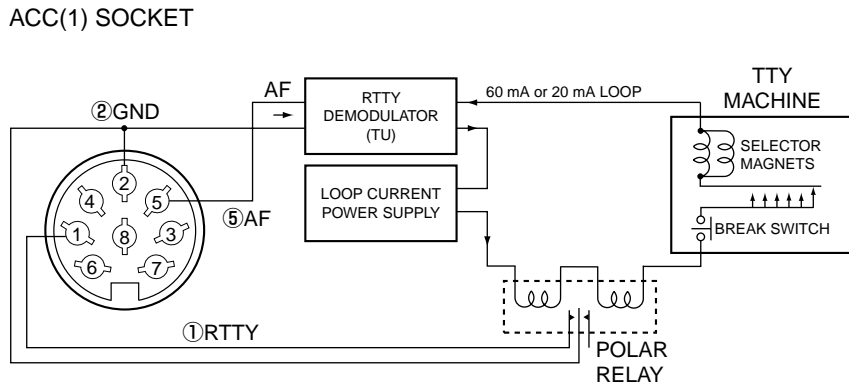

• When using a level converter

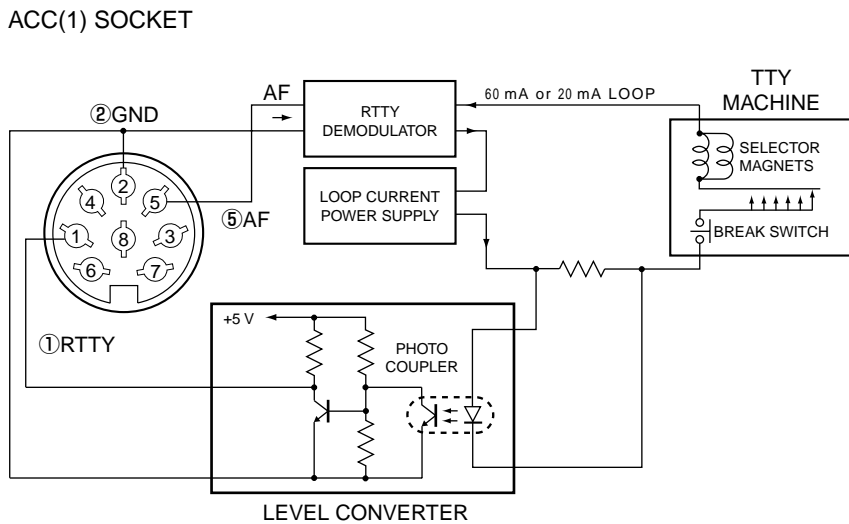

12-9 Remote jack

■ CI-V CONNECTION EXAMPLE

The transceiver can be connected through an optional CT-17 CI-V LEVEL CONVERTER to a personal computer equipped with an RS-232C port. The Icom Communications Interface-V (CI-V) controls the following functions of the transceiver.

Up to 4 Icom CI-V transceivers or receivers can be connected to a personal computer equipped with an RS-232C port. See p. 64 for setting the CI-V condition using set mode.

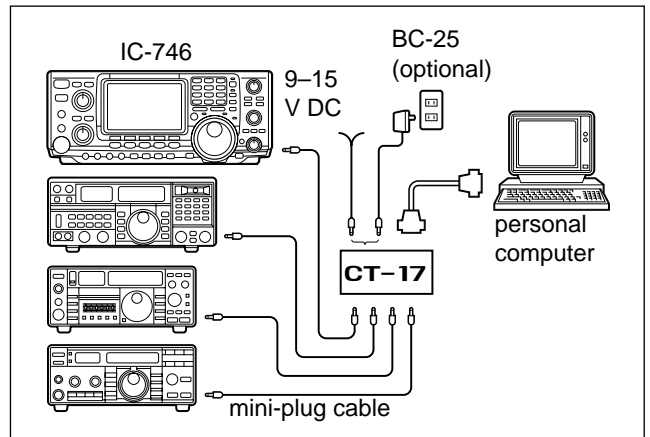

■ DATA FORMAT

The CI-V system can be operated using the following data formats. Data formats differ according to command numbers. A data area or sub command is added for some commands.

CONTROLLER TO IC-746

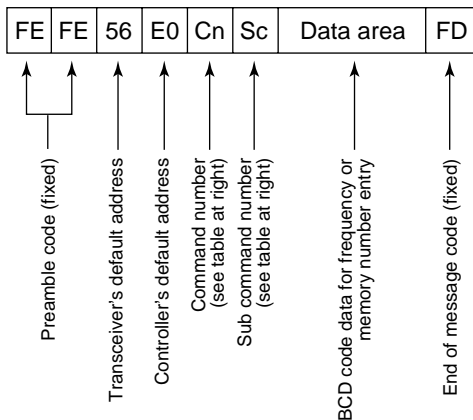

OK MESSAGE TO CONTROLLER

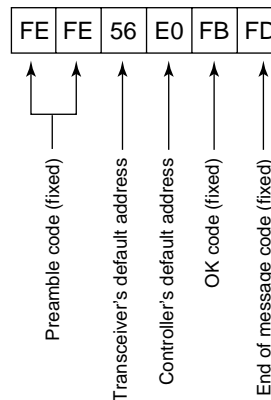

IC-746 TO CONTROLLER

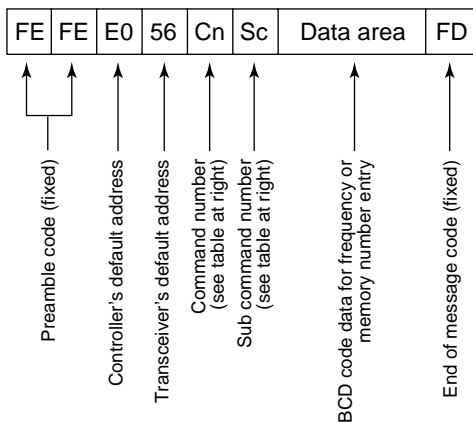

NG MESSAGE TO CONTROLLER

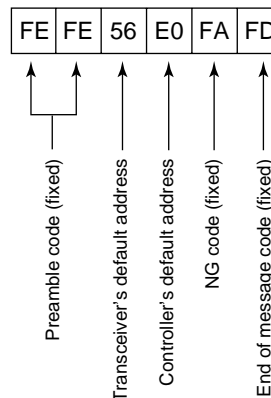

■ COMMAND TABLE

Cn	Sc	Description
00		Sets frequency (transceive)
01	xx	Sets mode (transceive)
02		Reads band edge frequency
03		Reads display frequency
04		Reads display mode
05		Sets frequency
06	00	Sets LSB mode
	01	Sets USB mode
	02	Sets AM mode
	03	Sets CW mode
	04	Sets RTTY mode
	05	Sets FM mode
	07	Sets CW-R mode
	08	Sets RTTY-R mode
07		Selects VFO operation
	00	Sets VFO A
	01	Sets VFO B
	A0	Sets VFO A=B
	B0	Exchanges VFO A and B
08		Select memory operation
	xx	Sets a M-CH (P1=0100/P2=0101/C=0102)
09		Writes to memory
0A		Transfers contents from memory to VFO
0B		Clears the memory channel
0C		Reads the duplex offset frequency
0D		Sets the duplex offset frequency
0E	00	Stops scan
	01	Starts program/memory scan
	02	Starts program scan
	03	Starts Δ F scan
	12	Starts fine program scan
	13	Starts fine Δ F scan
	22	Starts memory scan
	23	Starts select memory scan
	Ax	Sets the range for Δ F scan*1
	B0	Turns a "select" setting OFF
	B1	Turns a "select" setting ON
	D0	Turns scan resume OFF
D3	Turns scan resume ON	
0F	00	Turns split operation OFF
	01	Turns split operation ON
	10	Selects simplex operation
	11	Selects -duplex operation
	12	Selects +duplex operation

*17 spans are available (A1 to A7): ± 5 kHz, ± 10 kHz, ± 20 kHz, ± 50 kHz, ± 100 kHz, ± 500 kHz and ± 1 MHz.

*21 Hz when fine tuning is set.

*3When not writing data, reading is also possible.

*4Clear other channel counters before inputting a counter.

Cn	Sc	Description
10	00	Sets 10 Hz tuning step*2
	01	Sets 100 Hz tuning step
	02	Sets 1 kHz tuning step
	03	Sets 5 kHz tuning step
	04	Sets 9 kHz tuning step
	05	Sets 10 kHz tuning step
	06	Sets 12.5 kHz tuning step
	07	Sets 20 kHz tuning step
08	Sets 25 kHz tuning step	
11*3	xx	Toggles [ATT] ON/OFF (0=OFF, 20=ON)
12	01	Selects [ANT1] connector
	02	Selects [ANT2] connector
13	00	Sets UT-102 for S-level+freq.+mode
	01	Sets UT-102 for S-level+freq.
	02	Sets UT-102 for mode
14	01	Sets AF level (0 to 255)
	02	Sets RF gain (0=max. CCW; 255=11 o'clock)
	03	Sets squelch (0=11 o'clock CW; 255=max. CW)
	05	Sets APF level (0 to 255)
	06	Sets NR level (0 to 255)
	07	Sets [TWIN PBT] (inside) <small>0=narrows upper side 128=center</small>
	08	Sets [TWIN PBT] (outside) <small>255=narrows lower side</small>
	09	Sets the CW PITCH level (0 to 255)
	0A	Sets RF PWR (0 to 255)
	0B	Sets the MIC GAIN level (0 to 255)
0C	Sets the KEY SPEED level (0 to 255)	
15	01	Reads the squelch condition (open/closed)
	02	Reads the S-meter squelch level
16*3	02	Sets the pre-amp (0=OFF, 1=PAMP1, 2=PAMP2)
	12	Sets the AGC (0=OFF, 1=AGC-F, 2=AGC-S)
	22	Sets the NB (0=OFF, 1=ON)
	32	Sets the APF (0=OFF, 1=ON)
	40	Sets the NR (0=OFF, 1=ON)
	41	Sets the ANF (0=OFF, 1=ON)
	42	Sets the TONE (0=OFF, 1=ON)
	43	Sets the TSQL (0=OFF, 1=ON)
	44	Sets the COMP (0=OFF, 1=ON)
	45	Sets the MONITOR (0=OFF, 1=ON)
46	Sets the VOX (0=OFF, 1=ON)	
47	Sets the BK-IN (0=OFF, 1=semi BK-IN, 2=full BK-IN)	
19	00	Reads the transceiver's ID code
1A*3	00	Sets memory channel contents
	01	Sets bandstacking register contents
	02	Sets memory keyer contents*4
	03	Reads the IF filter setting
1B	00	Sets the tone frequency for repeater use
	01	Sets the tone frequency for tone squelch
1C	00	Exchanges transmit and receive (0=Rx, 1=Tx)

13 OPTIONAL INSTALLATIONS

13-1 Opening the transceiver's case

Follow the case and cover opening procedures shown here when you want to install an optional unit or adjust an internal unit, etc.

▽ CAUTION: DISCONNECT the DC power cable from the transceiver before performing any work on the transceiver. Otherwise, there is danger of electric shock and/or equipment damage.

- ① Remove the 2 screws from the left side of the transceiver to remove the carrying handle.
- ② Remove 6 screws from the top of the transceiver and 6 screws from the sides, then lift up the top cover.
- ③ Remove the 11 screws from the shield cover and the 2 screws from the speaker.
- ④ Remove the 6 screws from the bottom of the transceiver, then remove the bottom cover.

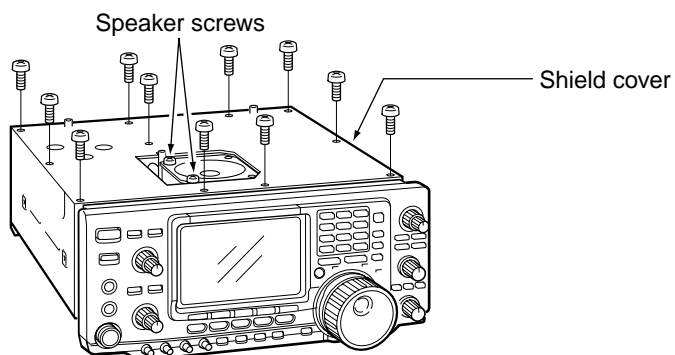
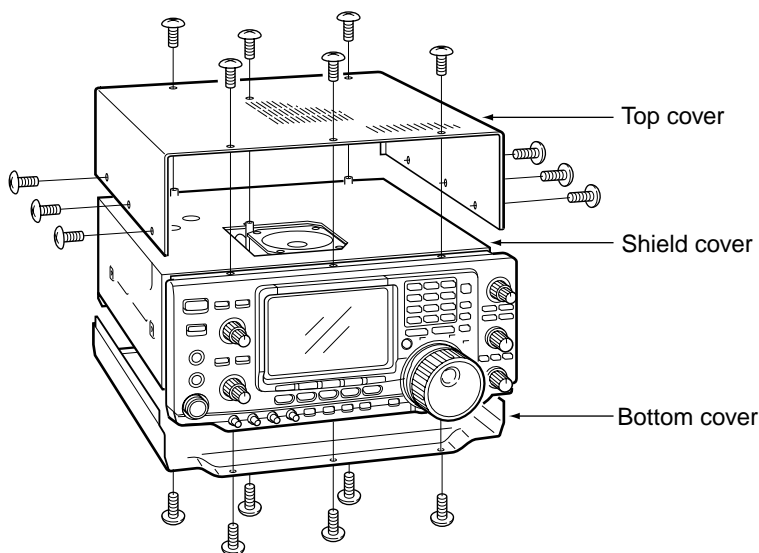
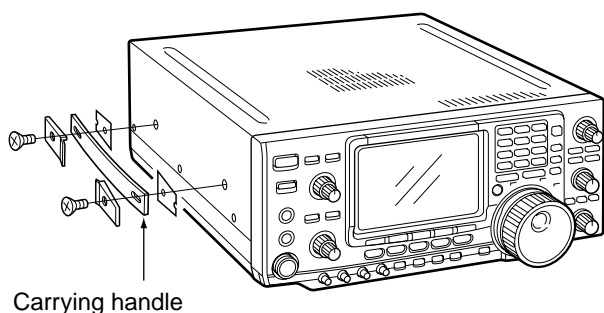

13-2 UT-102 VOICE SYNTHESIZER UNIT

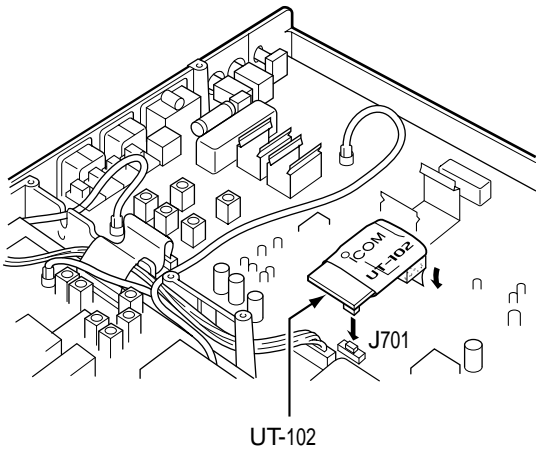

The UT-102 announces the accessed readout's frequency, mode, etc. (S-meter level can also be announced—p. 63) in a clear, electronically-generated voice, in English (or Japanese).

- ① Remove the bottom and shield covers.
- ② Remove the protective paper attached to the bottom of the UT-102 to expose the adhesive strip.
- ③ Plug UT-102 into J701 on the MAIN UNIT as shown at left.
- ④ Return the top and shield covers to their original positions.

13-3 CR-282 HIGH STABILITY CRYSTAL UNIT

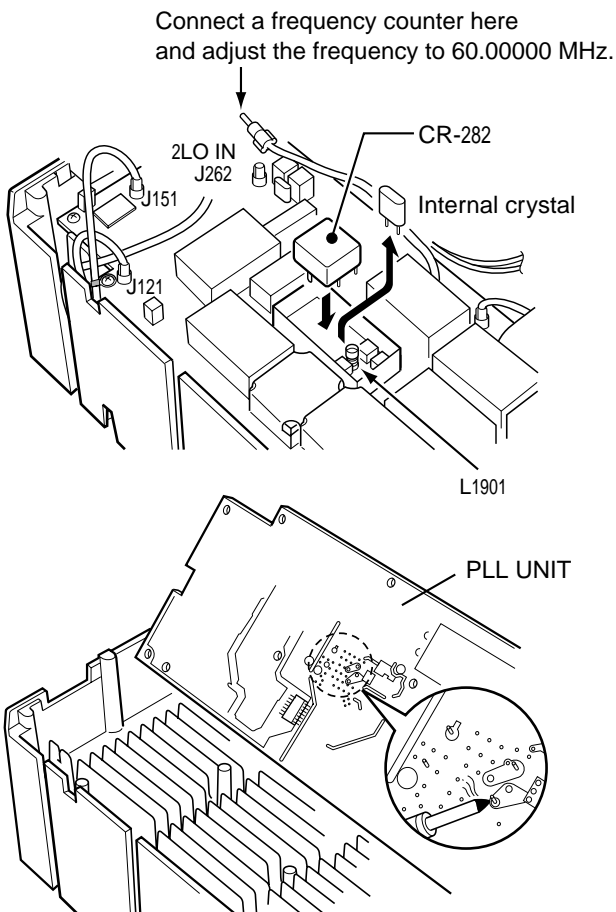

By installing the CR-282, the total frequency stability of the the transceiver will be improved.

- ① Remove the bottom cover as shown on the page opposite.
- ② Turn the transceiver upside down. Remove 8 screws from the PLL UNIT, disconnect J121 and J151, then remove the PLL UNIT.
- ③ Remove the supplied internal crystal and replace with the CR-282.
- ④ Adjust the reference frequency using a frequency counter.
- ⑤ Return the PLL UNIT and bottom cover to their original positions.

13-4 Optional IF filters

Several IF filters are available for the IC-746. You can install 2 filters for the 9 MHz IF and 1 filter for the 455 kHz IF. Choose appropriate filter(s) for your operating needs.

9 MHz optional filters:

FL-101 CW NARROW FILTER	250 Hz/-6 dB
FL-232 RTTY/CW NARROW FILTER	350 Hz/-6 dB
FL-100 CW NARROW FILTER	500 Hz/-6 dB
FL-223 SSB NARROW FILTER	1.9 kHz/-6 dB
FL-103 SSB WIDE FILTER	2.8 kHz/-6 dB

455 kHz optional filters:

FL-53A CW NARROW FILTER	250 Hz/-6 dB
FL-52A CW/RTTY NARROW FILTER	500 Hz/-6 dB
FL-222 SSB NARROW FILTER	1.8 kHz/-6 dB
FL-96 SSB WIDE FILTER	2.8 kHz/-6 dB
FL-257 SSB WIDE FILTER	3.3 kHz/-6 dB

Filter program mode

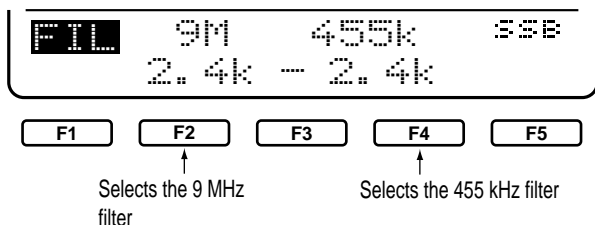

When selecting the narrow filter

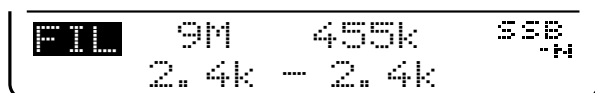

◆ INSTALLATION

- ① Remove the bottom cover (p. 76).
- ② Turn the transceiver upside down. Install the desired filter as shown in the diagram below.
 - The filters can be installed in either direction.
- ③ Replace the bottom cover.

◆ USING THE FILTERS

- ① Select an installed filter in set mode (pgs. 60, 61).
- ② Push [FILTER] for 2 sec. to enter filter program mode.
- ③ Push a mode key to select the desired operating mode.
- ④ Push [FILTER] to set the selected filter condition (normal or narrow).
- ⑤ Push [F-2] one or more times to select the desired 9 MHz filter.
- ⑥ Push [F-4] one or more times to select the desired 455 kHz filter.
- ⑦ Repeat steps ③ to ⑥ to set filters for other operating modes if desired.

INSTALLING 9 MHz FILTERS

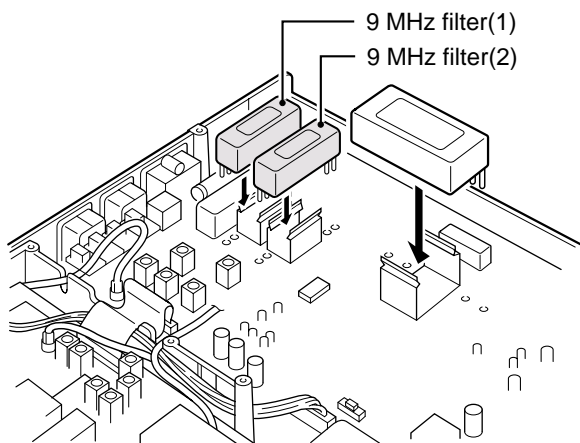

INSTALLING 455 kHz FILTERS

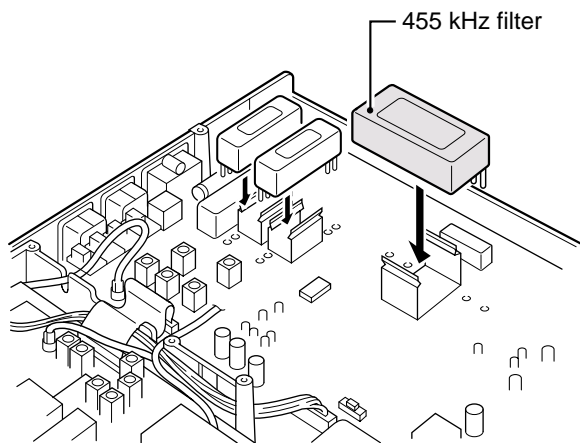

13-5 Linear amplifier connections

Refer to the manual supplied with the IC-PW1 for additional information.

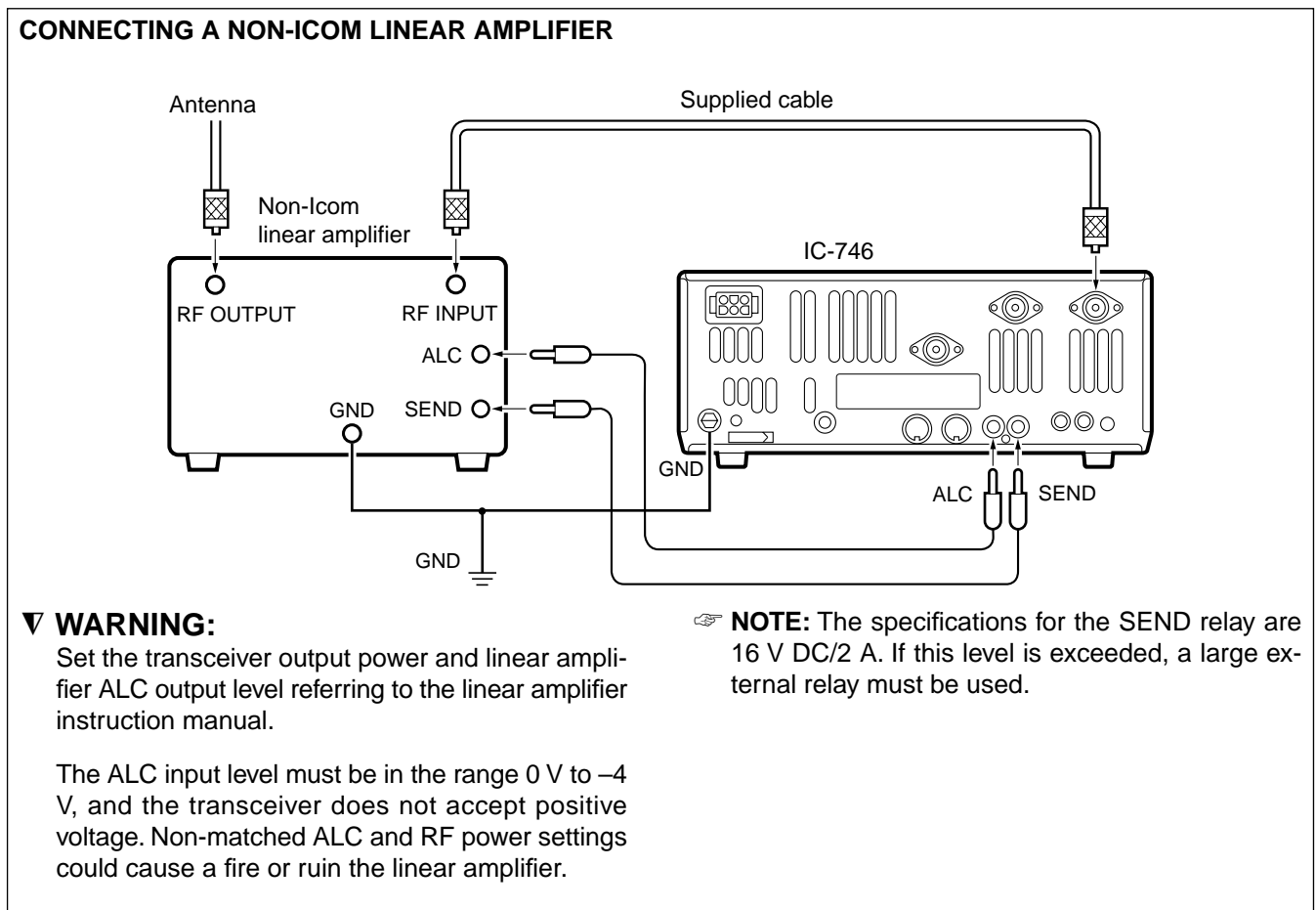
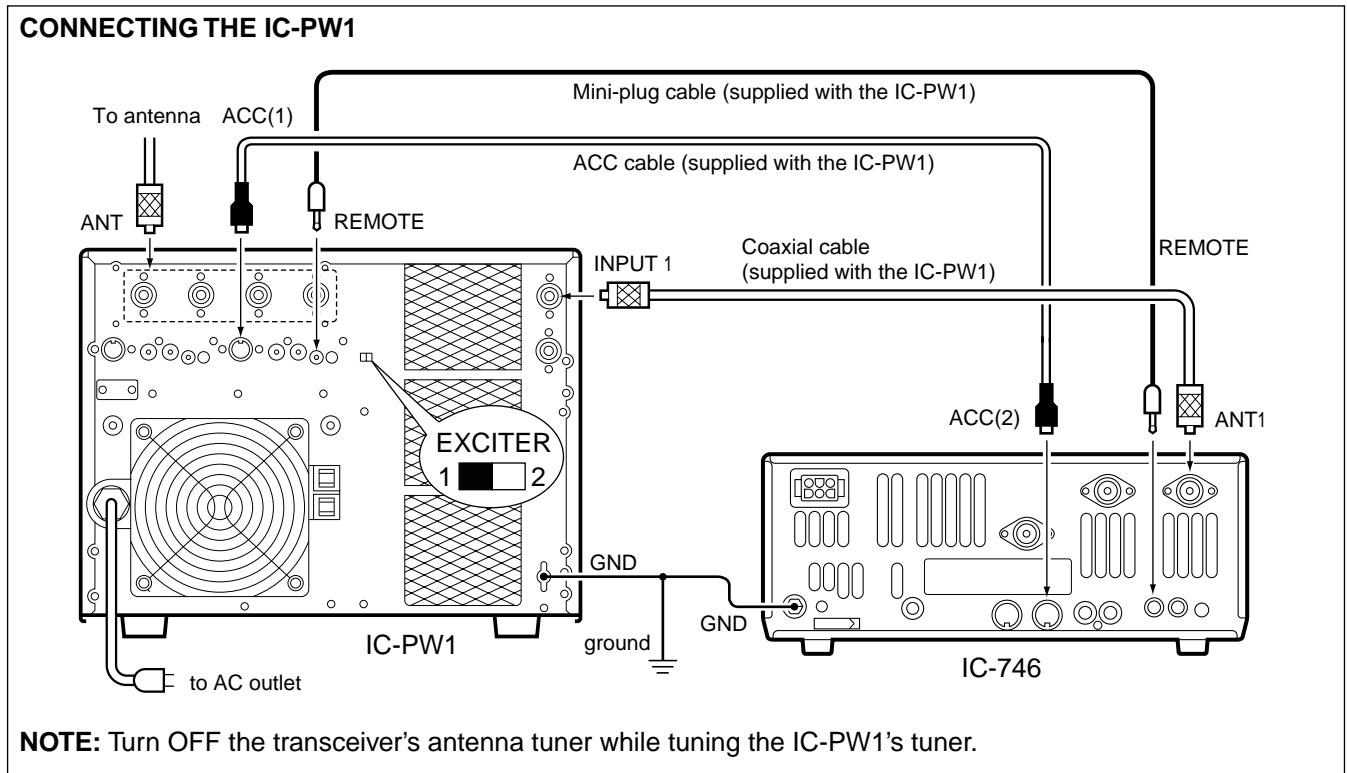

13-6 External antenna tuner connections

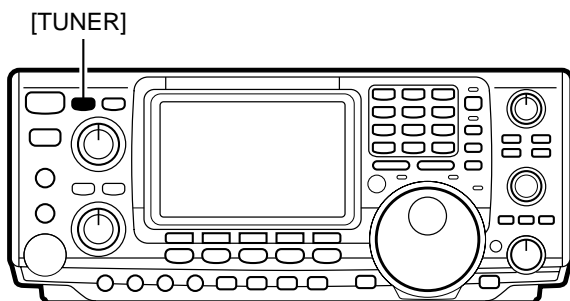
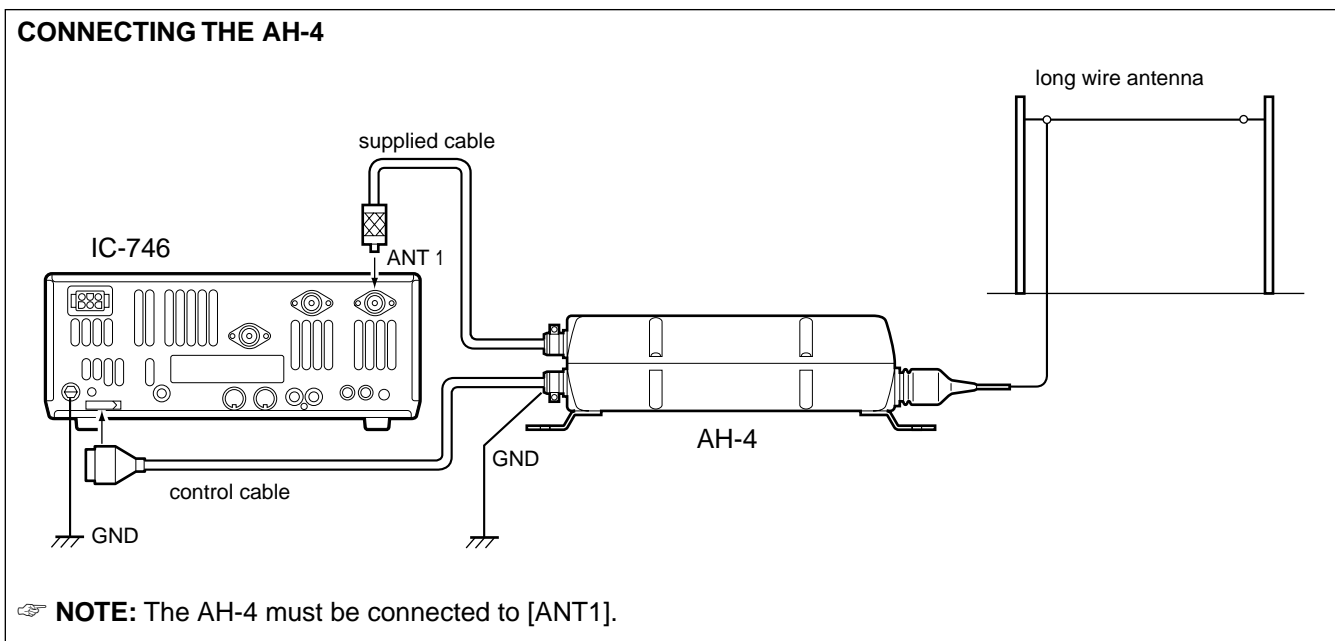

◆ OPERATING THE AH-4

- ① Connect the AH-4 to the transceiver as shown above.
- ② Push [POWER] to turn transceiver power on.
 - “EXIT” appears on the display.
 - The internal antenna tuner automatically enters the “through” condition.
- ③ Push [TUNER] for 2 sec.
 - The transceiver automatically selects CW mode and output power of 10 W; then, automatically tunes the connected antenna.
 - “TUNE” flashes during tuning.
- ④ When tuning is complete, the previously selected operating mode is automatically selected.
 - If tuning is not successful, “TUNE” disappears and the AH-4 is set to the “through” condition.
- ⑤ Push [TUNER] for 2 sec. to retune the antenna tuner when you change the operating frequency or band.

■ PTT TUNE FUNCTION

When [TUNER] is ON and the PTT tune function is ON in set mode, the transceiver automatically tunes HF bands when transmitting for the first time.

See p. 63 for setting the PTT tune function ON and OFF.

14-1 Fuse replacement

If a fuse blows or the transceiver stops functioning, try to find the source of the problem, and replace the damaged fuse with a new, rated fuse.

CAUTION: DISCONNECT the DC power cable from the transceiver when changing a fuse.

The IC-746 has 2 types of fuses installed for transceiver protection.

- DC power cable fuses FGB 20 A
- Circuitry fuse FGB 5 A

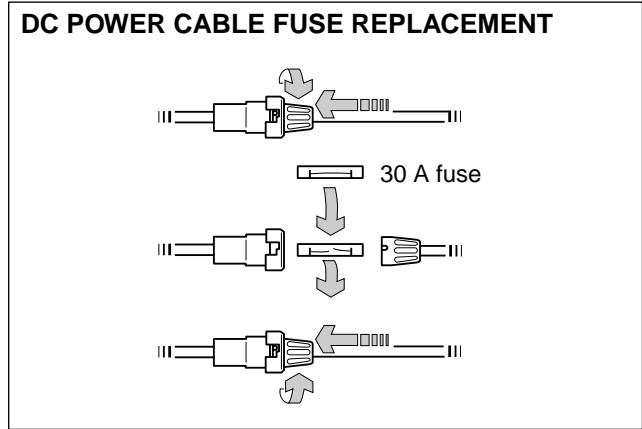

CIRCUITRY FUSE REPLACEMENT

The 13.8 V DC from the DC power cable is applied to all units in the IC-746, except for the power amplifier, through the circuitry fuse. This fuse is installed in the PA unit.

- ① Remove the top cover and PA shielding plate as shown on p. 76
- ② Replace the circuitry fuse as shown in the diagram at right.
- ③ Replace the PA shielding plate and top cover.

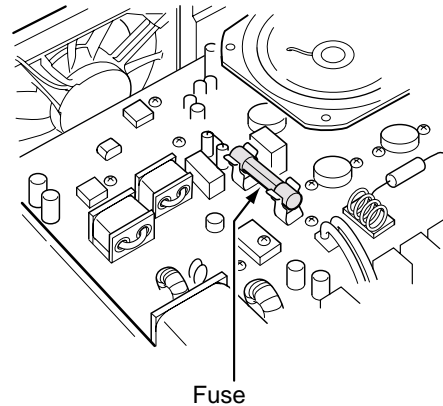

14-2 Resetting the CPU

NOTE: Resetting CLEARS all programmed contents in memory channels and returns programmed values in set mode to their defaults.

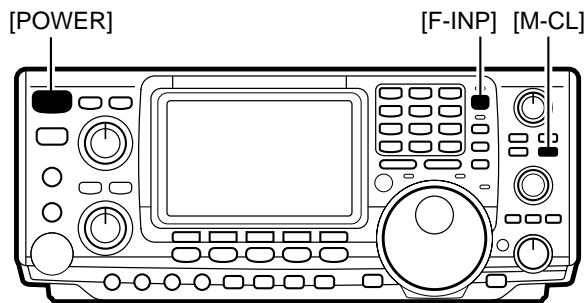

When first applying power or when the function seems to be displaying erroneous information, reset the CPU as follows:

- ① Make sure transceiver power is OFF.
- ② While pushing [F-INP] and [M-CL], push [POWER] to turn power ON.
 - The internal CPU is reset.
 - The transceiver displays its initial VFO frequencies when resetting is complete.

14-3 Troubleshooting

The following chart is designed to help you correct problems which are equipment malfunctions.

If you are not able to locate the cause of a problem or solve it through the use of this chart, contact your nearest Icom Dealer or Service Center.

	PROBLEM	POSSIBLE CAUSE	SOLUTION	REF.
POWER SUPPLY	Power does not come on when the [POWER] switch is pushed.	<ul style="list-style-type: none"> • DC power cable is improperly connected. • Fuse is blown. • Battery is exhausted if you are using a 12 V battery as the power source. 	<ul style="list-style-type: none"> • Reconnect the power cable correctly. • Check for the cause, then replace the fuse with a spare one. (Fuses are installed in two places. One is installed in the DC power cable and the other is installed in the PA unit.) • Check the battery voltage with the [POWER] pushed IN. 	<p>p. 68</p> <p>p. 81</p> <p>—</p>
	No sound comes from the speaker.	<ul style="list-style-type: none"> • Volume level is set too low. • The squelch is closed. • The transceiver is in the transmitting condition. • An external speaker or headphones are connected. 	<ul style="list-style-type: none"> • Rotate [AF] clockwise to obtain a suitable listening level. • Rotate [SQL] counterclockwise to open the squelch. • Release [PTT], on the microphone, push [TRANSMIT] or check the SEND line of an external unit, if connected. • Check the external speaker or headphone plug connection. • Check the speaker A/B switch, when an optional SP-20 is in use. 	<p>p. 12</p> <p>p. 3</p> <p>—</p> <p>p. 67</p> <p>—</p>
RECEIVE	Sensitivity is low.	<ul style="list-style-type: none"> • The antenna is not connected properly. • The antenna feed line is cut or shorted. • The antenna for another band is selected. • The antenna is not properly tuned. • The attenuator function is activated. 	<ul style="list-style-type: none"> • Reconnect to the antenna connector. • Check the feed line and correct any improper conditions. • Select an antenna suitable for the operating frequency. Make sure that [ANT1] is used for frequencies less than 60 MHz and [ANT2] is used for frequencies of 60 MHz and above. • Push [TUNE] to manually tune the antenna. • Push [ATT] to turn the function OFF. 	<p>—</p> <p>—</p> <p>p. 71</p> <p>pgs. 59</p> <p>p. 38</p>
	Receive audio is distorted.	<ul style="list-style-type: none"> • The operating mode is not selected correctly. • The [RIT] control is set off-center. 	<ul style="list-style-type: none"> • Select a suitable operating mode. • Set [RIT] to the center position. 	<p>p. 17</p> <p>p. 38</p>
	Receive signal is distorted with strong signals.	<ul style="list-style-type: none"> • Noise blanker function is activated. • Preamp is activated. 	<ul style="list-style-type: none"> • Push [NB] to turn the function OFF. • Push [P.AMP] to turn the function OFF. 	<p>p. 39</p> <p>p. 38</p>

	PROBLEM	POSSIBLE CAUSE	SOLUTION	REF.
TRANSMIT	Transmitting is impossible.	<ul style="list-style-type: none"> The operating frequency is not set to a ham band. The split frequency function is turned ON with different bands in VFO A and VFO B. 	<ul style="list-style-type: none"> Set the frequency to a ham band. Turn OFF the split frequency function. 	<p>p. 84</p> <p>p. 47</p>
	Output power is too low.	<ul style="list-style-type: none"> Power is set lower power than maximum. Microphone gain is set too low. The antenna is not connected properly. The antenna feed line is cut or shorted. An antenna for another band is selected. The antenna is not properly tuned. 	<ul style="list-style-type: none"> Set the output power to maximum. Set microphone gain using the [MIC GAIN] control. Reconnect the antenna connector. Check the feed line and correct any improper conditions. Select an antenna suitable for the operating frequency. Push [TUNE] to manually tune the antenna when an optional antennal tuner is connected. 	<p>p. 3</p> <p>p. 3</p> <p>—</p> <p>—</p> <p>p. 71</p> <p>pgs. 59</p>
	No contact possible with other stations.	<ul style="list-style-type: none"> RIT function is activated. Split function is activated. 	<ul style="list-style-type: none"> Push RIT to turn the function OFF. Push [SPLIT] to turn the function OFF. 	<p>p. 38</p> <p>p. 47</p>
	Repeater cannot be accessed.	<ul style="list-style-type: none"> Split function is not activated. An incorrect transmit frequency is set. Subaudible tone encoder is OFF and repeater requires a tone for access. Programmed subaudible tone frequency is wrong. 	<ul style="list-style-type: none"> Push [SPLIT] to turn the function ON. Set the proper frequencies into VFO A and B or into one of the memory channels. Use [TON] in menu set 1 to select tone operation. Program the required frequency using the repeater tone frequency menu. 	<p>p. 47</p> <p>p. 84</p> <p>p. 34</p> <p>p. 34</p>
	Transmitted signals are distorted.	<ul style="list-style-type: none"> Microphone gain is set too high. [COMP GAIN] is rotated too far clockwise with the speech compressor ON. 	<ul style="list-style-type: none"> Rotate [MIC GAIN] counterclockwise. Set [COMP GAIN] to a suitable position. 	<p>p. 3</p> <p>p. 46</p>
DISPLAY	Displayed frequency does not change properly.	<ul style="list-style-type: none"> The dial lock function is activated. The internal CPU has malfunctioned. 	<ul style="list-style-type: none"> Push [LOCK] to deactivate the function. Reset the CPU. (While pushing [F-INP] and [M-CL] push [POWER] to turn power ON. 	<p>p. 40</p> <p>p. 81</p>
SCAN	Programmed scan does not stop.	<ul style="list-style-type: none"> Squelch is open. 	<ul style="list-style-type: none"> Set squelch to the threshold position. 	<p>p. 12</p>
	Programmed scan does not start.	<ul style="list-style-type: none"> The same frequencies have been programmed in scan edge memory channels P1 and P2. 	<ul style="list-style-type: none"> Program different frequencies into scan edge memory channels P1 and P2. 	<p>p. 56</p>
	Memory scan does not start.	<ul style="list-style-type: none"> 2 or more memory channels have not been programmed. 	<ul style="list-style-type: none"> Program 2 or more memory channels. 	<p>p. 57</p>
	Memory select scan does not start.	<ul style="list-style-type: none"> 2 or more memory channels have not been designated as select channels. 	<ul style="list-style-type: none"> Designate 2 or more memory chan- 	<p>p. 57</p>

15 SPECIFICATIONS AND OPTIONS

15-1 Specifications

GENERAL

• Frequency coverage :	Unit: MHz
Receive	0.030– 60.000* ¹
Transmit	108.000– 174.000* ¹
	1.800– 1.999* ²
	3.500– 3.999* ²
	7.000– 7.300* ²
	10.100– 10.150
	14.000– 14.350
	18.068– 18.168
	21.000– 21.450
	24.890– 24.990
	28.000– 29.700
	50.000– 54.000* ²
	144.000– 148.000* ²

*¹Except for some frequency ranges.

*²Depending on version.

- Mode : USB, LSB, CW, RTTY, AM, FM
- No. of memory ch : 102 (99 regular, 2 scan edges and 1 call)
- Antenna connector : SO-239×3 (2 for HF/50 MHz and 1 for 144 MHz; 50 Ω)
- Usable temp. range : -10°C to 60°C (14°F to 140°F)
- Frequency stability : Less than ±7 ppm from 1 min. to 60 min. after power on. After that, rate of stability is less than ±1 ppm/hr. at +25°C (+77°F). Temperature fluctuations 0°C to +50°C (+20°F to +122°F) less than ±5 ppm.
- Frequency resolution : 1 Hz
- Power supply requirement : 13.8 V DC±15% (negative ground)
- Current drain :

Transmit	max. power	20.0 A
Receive	standby	1.8 A
	max. audio	2.0 A
- Dimensions : 287(W)×120(H)×316.5(D) mm
11⁵/₁₆(W)×4²³/₃₂(H)×12¹⁵/₃₂(D) in
- Weight : 8.9 kg; 19 lb 10 oz
- CI-V connector : 2-conductor 3.5 (d) mm (1/8")

TRANSMITTER

- Output power :

USB, LSB, FM	5–100 W
AM	5–40 W
- Modulation system :

USB, LSB, AM	Balanced modulation
FM	Variable reactance modulation
- Spurious emissions : Less than -50 dB (HF)
Less than -60 dB (50/144 MHz)
- Carrier suppression : 40 dB
- Unwanted sideband : 50 dB
- ΔTX variable range : ±9.999 kHz
- Mic. connector : 8-pin connector (600 Ω)

RECEIVER

- Sensitivity (typical) :

USB, LSB, AM, RTTY (10 dB S/N)	0.16 μV* ¹ (1.8–29.990 MHz)
	0.13 μV* ² (50 MHz)
	0.11 μV* ³ (144 MHz)
AM (10 dB S/N)	13 μV (0.5–1.799 MHz)
	2.0 μV* ¹ (1.8–29.990 MHz)
	1.0 μV* ² * ³ (50/144 MHz)
FM (12 dB SINAD)	0.5 μV* ¹ (28–29.990 MHz)
	0.25 μV* ² (50 MHz)
	0.18 μV* ³ (144 MHz)

*¹Preamp-1 ON, *²Preamp-2 ON, *³Preamp ON
- Selectivity :

USB, LSB, CW, RTTY	More than 2.1 kHz/-6 dB
	Less than 4.0 kHz/-60 dB
AM, FM-N	More than 9.0 kHz/-6 dB
	Less than 20.0 kHz/-40 dB
FM	More than 12 kHz/-6 dB
	Less than 30 kHz/-50 dB
- Squelch sensitivity :

USB, LSB, CW, RTTY	Less than 5.6 μV
FM	Less than 1.0 μV
- Spurious and image rejection ration: (except IF through on 50 MHz)

	More than 70 dB
	More than 60 dB (144 MHz)
- RIT variable range : ±9.999 kHz
- Audio output power : More than 2.0 W (at 13.8 V DC with an 8 Ω load)

All stated specifications are subject to change without notice or obligation.

SUPPLIED ACCESSORIES

	Qty.
① DC power cable (OPC-025A)	1
② Hand microphone (HM-36)	1
③ Spare fuses (FGB 20A)	2
④ Spare fuses (FGB 5A)	1
⑤ CW keyer plug (AP-330)	1

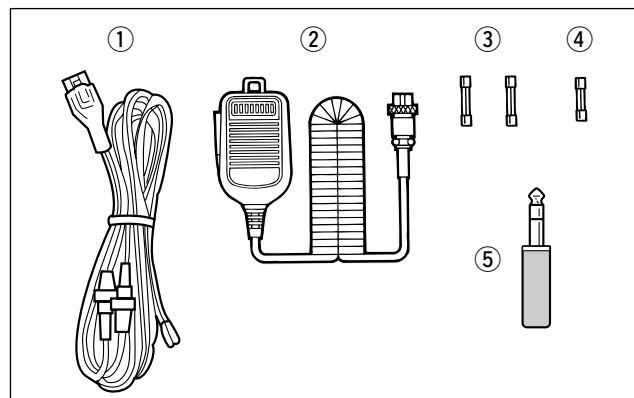

15-2 Options

<p>IC-PW1 HF + 50 MHz 1 kW LINEAR AMPLIFIER</p>	<p>EX-627 AUTOMATIC ANTENNA SELECTOR</p> <p>Automatically selects the antenna for the selected HF ham band.</p> <ul style="list-style-type: none"> • Max. input power: 1000 W PEP 	
<p>AH-4 HF AUTOMATIC ANTENNA TUNER</p>	<p>AH-2b ANTENNA ELEMENT</p> <p>A 2.5 m long antenna element for mobile operation with the AH-4.</p> <ul style="list-style-type: none"> • Frequency coverage: 3.5–28 MHz bands with the AH-4 	<p>PS-85 POWER SUPPLY</p> <p>Light weight switching regulator system power supply.</p> <ul style="list-style-type: none"> • Output voltage: 13.8 V DC • Max. current drain: 20 A
<p>SM-20 DESKTOP MICROPHONE</p> <p>Unidirectional, electret microphone for base station operation. Includes [UP]/[DOWN] switches and a low cut function.</p>	<p>FL-100, FL-101, FL-103, FL-223 and FL-232 9 MHz FILTERS</p> <ul style="list-style-type: none"> • FL-100: 500 Hz/–6 dB (CW/RTTY nar.) • FL-101: 250 Hz/–6 dB (CW nar.) • FL-103: 2.8 kHz/–6 dB (SSB wide) • FL-223: 1.9 kHz/–6 dB (SSB nar.) • FL-232: 350 Hz/–6 dB (RTTY/CW nar.) 	<p>FL-52A, FL-53A, FL-96, FL-222 and FL-257 455 kHz FILTERS</p> <ul style="list-style-type: none"> • FL-52A: 500 Hz/–6 dB (CW/RTTY nar.) • FL-53A: 250 Hz/–6 dB (CW nar.) • FL-96: 2.8 kHz/–6 dB (SSB wide) • FL-222: 1.8 kHz/–6 dB (SSB nar.) • FL-257: 3.3 kHz/–6 dB (SSB wide)
<p>SM-8 DESKTOP MICROPHONE Electret condenser-type desktop microphone including 2 connection cables for simultaneous connection of 2 transceivers. [UP] and [DOWN] switches are included.</p> <p>CT-16 SATELLITE INTERFACE UNIT Easy tuning when connecting another Icom VHF/UHF transceiver for instant satellite communications.</p>	<p>CT-17 CI-V LEVEL CONVERTER For remote transceiver control using a personal computer. You can change frequencies, operating mode, memory channels, etc.</p> <p>SP-21 EXTERNAL SPEAKER Designed for base station operation. Input impedance: 8 Ω Max. input power: 5 W</p>	<p>CR-282 HIGH-STABILITY CRYSTAL UNIT Contains a temperature-compensating oven heater and crystal unit for improved frequency stability.</p> <ul style="list-style-type: none"> • Frequency stability: ±0.5 ppm <p>UT-102 VOICE SYNTHESIZER UNIT Announces operating frequency, mode and S-meter level.</p>

Count on us!

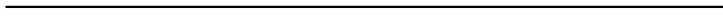
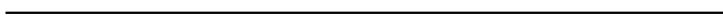
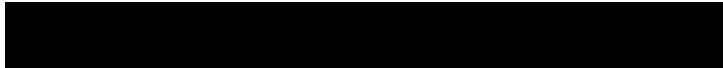

IC-746 ADDENDUM

On page 53 of the IC-746 Instruction Manual, the text at right appears regarding assigning memory names. The following should be added to the bullet list in step ⑥:

- Use the keypad to directly input numerals, “0” to “9,” including a decimal point.

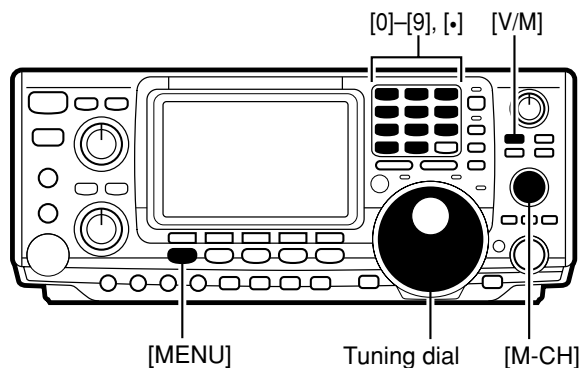

Memory names can be assigned to any memory channel. Memory names can be up to 9 characters in length; any of the 127 standard ASCII characters (as on a computer keyboard) can be used.

[EXAMPLE]: Programming “DX spot” into memory channel 99.

- ① Push [V/M] to select memory mode, if necessary.
- ② Rotate [M-CH] to select memory channel 99.
- ③ Push [MENU] to select menu set 2.
- ④ Push [F2](MEM) to select the memory name menu.
- ⑤ Push [F1](EDT) to select the memory edit menu.
- ⑥ Push [F1](ABC) one or more times to select the type of characters for input.
 - “ABC” inputs capital letters A to Z.
 - “abc” inputs small letters a to z.
 - “etc” is used to input other characters such as punctuation.
- ⑦ Rotate the tuning dial to select the first character for input.
- ⑧ Push [F3](←) or [F2](→) to move the cursor forwards or backwards, respectively.
 - [F5](SPC) inserts a space and [F4](DEL) deletes a character.
- ⑨ Repeat steps ⑥ to ⑧ to input the remainder of the name.
- ⑩ Push [MENU] to set the memory name and return to the memory name menu.
 - Push [MENU] 2 more times to return to menu set 1.

ERRATUM

Please note that the instruction manual for the IC-746 does not list the supplied accessories as shown below.

Accessories supplied with the IC-746:

	Qty.
① DC power cable (OPC-025A)	1
② Hand microphone (HM-36)	1
③ Spare fuses (FGB 20A)	2
④ Spare fuses (FGB 5A)	1
⑤ CW keyer plug (AP-330)	1